



# Andrea® 11

## 60" x 36" x 20.75"

**GENERAL SPECIFICATIONS:**

- Material** - Acrylic
- Installation** - Drop-in or Undermount
- Plumbed Weight** - 125 lbs / 57 kg
- Soaker Weight** - 100 lbs / 45 kg
- Average Fill** - 46 gal to above jet level
- Maximum Fill** - 90 gal to overflow

*NOTE: Filling this tub to the maximum may require an above average size or dedicated water heater.*

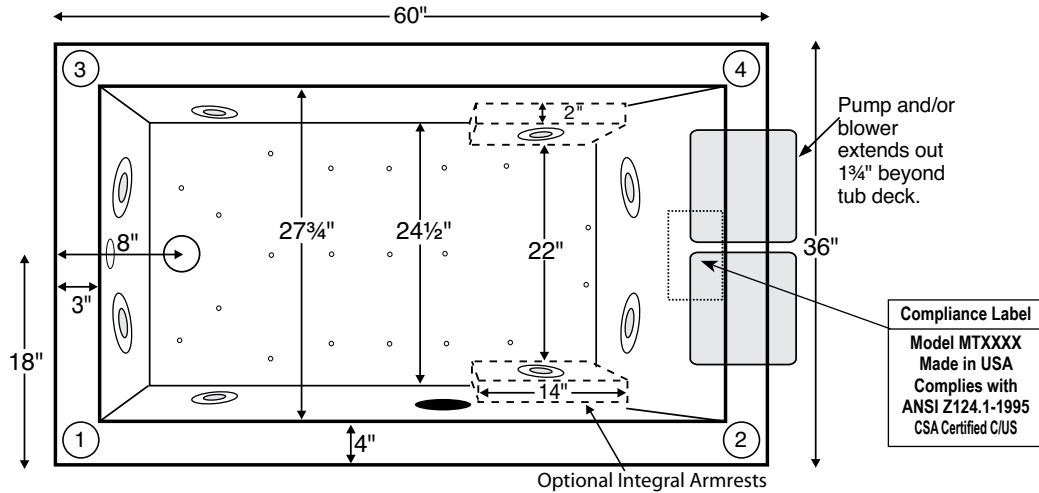

Numbered areas on tub deck represent possible locations to install cleaning systems, faucets and other fixtures.

**Pump extends out approximately 1 3/4" beyond tub deck.**

Shown with Air Massage and Ultra Whirlpool Package.

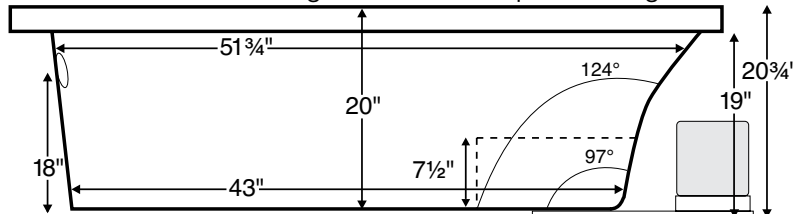

**IMPORTANT:**  
Air baths and tubs with a pre-leveled foam base or frame system add 2-3" to overall tub height.

ELECTRICAL COMPONENTS & SPECIFICATIONS		
Required Electrical Service - 110 Volt		
Hydrotherapy Package	Components Included	GFCI
Standard Whirlpool	2-bhp pump	1-15 amp
Ultra Whirlpool	2 2-bhp pumps, inline heater	2-20 amp
Air Massage	heated blower	1-15 amp
Air Massage Elite	heated blower, chromatherapy	1-15 amp
Air Massage with Standard Whirlpool	2-bhp pump, heated blower	2-15 amp
Air Massage with Ultra Whirlpool	2 2-bhp pumps, inline heater, heated blower	2-20 amp
Air Massage Elite with Standard Whirlpool	2-bhp pump, heated blower, chromatherapy	2-15 amp
Air Massage Elite with Ultra Whirlpool	2 2-bhp pumps, inline heater, heated blower, chromatherapy	2-20 amp

*For electrical requirements of tub options, see specific options specs*  
CSA Certified C/US; ANSI Z124.1 for plastic tubs and ANSI 112.19.7 for whirlpool components.

**IMPORTANT ORDERING & INSTALLATION INFORMATION:**

- Before ordering or installing, please consider future access to equipment.
- Add bedding compound to fully level and support bottom of tub.
- Tubs equipped with an air bath or a pre-leveled foam base are designed to rest on the floor without bedding compound, provided the floor is level.
- **Overall tub height is increased by approx. 2-3" when tub is equipped with any air bath package or when pre-leveled foam base or frame system is ordered.**
- Radiance placed on floor locations will affect placement of air jets.
- Please measure tub **on-site** before building tub decking.
- If you are planning to use a glass enclosure, MTI must be advised when ordering for possible relocation of controls.
- Suction and control locations may vary.
- Specifications and configurations are subject to change without notice.
- Measurements are  $\pm 1/2"$  and are subject to change without notice.
- Measurements herein supersede all others published prior to publication date shown below.













See the "Designer Collection Tubs Installation & Operation Manual" included with tub delivery or go to [mtibaths.com/support/installation\\_operation/manuals](http://mtibaths.com/support/installation_operation/manuals) for all the information necessary to install and operate the tub.

MTI's Customer Service Department is available Monday-Friday 8am-6pm EST at 800-783-8827 or [customerservice@mtibaths.com](mailto:customerservice@mtibaths.com) to answer any questions pertaining to ordering or installation.



## Packages and Pricing

For more information on any of the following packages, please visit: [mtibaths.com/therapies-for-wellness/](http://mtibaths.com/therapies-for-wellness/)

Hydrotherapy Packages	Package Contents	Part #	MSRP
 Soaker	Soaking bath - no jets	S101-DI	\$2,110
		S101-UM	
 Stream Bath	6 side vents, 2 end vents, 1-bhp pump	SM101-DI	\$3,960
		SM101-UM	
 Air Massage	20 air jets, heated air blower, Aromatherapy, pre-leveled foam base (increases overall height 2-3")	AST101-DI	\$4,925
		AST101-UM	
 Air Massage Elite	30 air jets, heated air blower, Aromatherapy, Chromotherapy LED lighting, Spa Mode, pre-leveled foam base (increases overall height 2-3")	AE101-DI	\$6,655
		AE101-UM	
 Stream Bath with Air Massage	6 side vents, 2 end vents, 1-bhp pump, 20 air jets, heated air blower, Aromatherapy, pre-leveled foam base (increases overall height 2-3")	ASTSM101-DI	\$6,775
		ASTSM101-UM	
 Stream Bath with Air Massage Elite	6 side vents, 2 end vents, 1-bhp pump, 30 air jets, heated air blower, Aromatherapy, Chromotherapy LED lighting, Spa Mode, pre-leveled foam base (increases overall height 2-3")	AESM101-DI	\$8,505
		AESM101-UM	
 Standard Whirlpool	6 point-massage jets, 2-bhp pump	P101-DI	\$4,145
		P101-UM	
 Ultra Whirlpool	8 point-massage jets, 2-bhp pump, inline heater, Ozone	P101U-DI	\$5,245
		P101U-UM	
 Air Massage with Standard Whirlpool	6 point-massage jets, 2-bhp pump, 20 air jets, heated air blower, Aromatherapy, pre-leveled foam base (increases overall height 2-3")	AW101-DI	\$7,095
		AW101-UM	
 Air Massage with Ultra Whirlpool	8 point-massage jets, 2-bhp pump, inline heater, 20 air jets, heated air blower, Aromatherapy, Ozone, pre-leveled foam base (increases overall height 2-3")	AU101-DI	\$8,210
		AU101-UM	
 Air Massage Elite with Standard Whirlpool	6 point-massage jets, 2-bhp pump, 30 air jets, heated air blower, Aromatherapy, Chromotherapy LED lighting, Spa Mode, pre-leveled foam base (increases overall height 2-3")	AEAP101-DI	\$9,160
		AEAP101-UM	
 Air Massage Elite with Ultra Whirlpool	8 point-massage jets, 2-bhp pump, inline heater, 30 air jets, heated air blower, Aromatherapy, Ozone, Chromotherapy LED lighting, Spa Mode, pre-leveled foam base (increases overall height 2-3")	AEAP101U-DI	\$10,180
		AEAP101U-UM	

**Lead Time** - Soakers, Stream Bath and Whirlpool Packages - 5 business days  
Air Baths and Combo Packages - 7 business days

**NOTES:** • Aromatherapy is eliminated for undermount applications  
• Air Baths, Pre-Leveled Foam Base or Frame Systems increase overall height by 2-3".

### RECOMMENDED SENSORY THERAPIES

SEE NEXT PAGE FOR AN OVERVIEW OF AVAILABLE OPTIONS.



**Chromotherapy**  
Underwater lighting is provided by digitally controlled LEDs. Different colors are thought to have different therapeutic effects.

LE - \$610



**Audiotherapy**  
Stereo H<sub>2</sub>O lets you "feel" the music through the bath water. Available with Bluetooth system or transducers with leads to connect to an external system.

STEREOH202 - \$1,135  
STEREOBT - \$1,235



**Thermotherapy**  
Radiance uses integrated radiant heat to warm the backrest for neck, shoulders and back. Inline heaters maintain bath water temperature.

RAD100 - \$1,080  
HTISOAK - \$750



**Microbubbles**  
For wellness and beauty, billions of the tiniest air bubbles saturate the water with dissolved oxygen to moisturize and soften the skin. Available for soakers and air baths.

MICRO - \$1,745



## Options and Pricing

For more information on any of the following options, please visit: [mtibaths.com/tub-options/](http://mtibaths.com/tub-options/)

### Premium Options

NOTE: part codes for all options listed in parenthesis.

<b>Microbubbles</b> - Available on Soakers and Air Baths only (MICRO) <b>\$1,745</b>
<b>Radiance</b> - integrated tub shell heating system (RAD100) <b>\$1,080</b>
<b>Chromatherapy</b> - Included in some hydrotherapy packages underwater LED lighting (LE) <b>\$610</b>
<b>Stereo H<sub>2</sub>O - Standard System</b> - includes 4 integrated audio transducers with leads to connect to an external audio source (STEREOH202) <b>\$1,135</b> <b>Bluetooth System</b> - integrated Bluetooth system allows you to directly connect to an applicable device (STEREOBT) <b>\$1,235</b>

### Standard Options

<b>Standard Colors:</b> White (CWH), Bone (CBN), Biscuit (CBS) <b>Color Upgrade:</b> (COL2) <b>\$500</b> , please call for availability of special colors
<b>Quick Ship</b> - reduces lead time - please call for availability (QSPRI) <b>\$380</b>
<b>Textured, Slip-Resistant Bottom</b> - meets ASTM F-462-1994 (TXBTM) <b>\$75</b>
<b>Virtual Spout</b> - high-flow integrated tub filler (FPMJ) <b>\$310</b>
<b>Low-Profile Rim</b> - reduces rim height to 1" (LPR) <b>\$125</b>
<b>Integral Armrests</b> - 1 pair (INTARM) <b>\$125</b>
<b>Inline Heater</b> - included in some hydrotherapy packages For whirlpools or Stream Bath (HTI) <b>\$545</b> Uses existing pump Soaker or Air Baths (HTISOAK) <b>\$750</b> Includes a recirculating pump.

### Installation Aids

<b>Tile Flange</b> must specify flange location(s) on order Note: Tile flange not available with Low-Profile Rim option. Factory-Installed on 3 sides - rigid ABS (TFK3) <b>\$190</b> Field Install Kit - includes rigid ABS & adhesive (TFKNI) <b>\$175</b>
<b>Pre-Levelled Foam Base</b> - for soaker or whirlpools (PLFOAM) <b>\$175</b>
<b>Pre-Levelled Frame and Foam Base (PLF)</b> <b>\$525</b>
<b>Pre-Levelled Frame and Foam Base with Skirting</b> See skirting options pricing and specs online.

### Accessories & Hardware for All Packages

<b>Drain Kits</b> - other finishes also available
<b>Toe-Tap with Slim-Line Integrated Overflow</b> Choose from: Chrome (SLOT), Brushed Nickel (SLOTBN), Polished Nickel (SLOTPN) or White (SLOTWH) <b>\$390</b>
<b>Toe-Tap with Rectangular Overflow -</b> Chrome (WOTRC) <b>\$285</b> Brushed Nickel (WOTRBN) <b>\$290</b> White (WOTRW) <b>\$290</b>
<b>Toe-Tap with Round Overflow -</b> Chrome (WOTTC) <b>\$285</b> Brushed Nickel (WOTTBN) <b>\$290</b> Polished Nickel (WOTTPN) <b>\$340</b>
<b>Cable Driven -</b> Chrome (WOCD) <b>\$315</b> Brushed Nickel (WOCDBN) <b>\$385</b> Polished Nickel (WOCDPN) <b>\$515</b> Oil-Rubbed Bronze (WOCBOR) <b>\$515</b>
<b>Lift &amp; Turn</b> - Chrome (WOC) <b>\$125</b> Brushed Nickel (WOBN) <b>\$225</b>
<b>Grab Bars</b> - 9" Curved, set of 2 Acrylic - color-matched with tub standard colors only (GB) <b>\$300</b> Metal - Chrome (GBMCC), Brushed Nickel (GBMCCBN) <b>\$330</b>
<b>Pillows</b> - from <b>\$125</b> See pillows pricing and specs online.
<b>Teak Tub Tray</b> - Slatted (TK-TRAY1) or Solid (TK-TRAY2) <b>\$415</b>
<b>Teak Bath Mat</b> (TK-MAT3018) <b>\$430</b> custom sizes also available
<b>Accessories &amp; Cleaning Systems for Whirlpool Packages</b>
<b>Trim Kits</b> - must be ordered at time of purchase; other finishes available Standard Whirlpool - Chrome (TRC) <b>\$235</b> ; Brushed Nickel (TRBN) <b>\$595</b> Ultra Whirlpool - Chrome (TRCU) <b>\$320</b> ; Brushed Nickel (TRBNU) <b>\$815</b>
<b>Pump Upgrade</b> - 3-bhp (PUMP3) <b>\$245</b>
<b>Additional Jet Options</b> See jet options pricing and specs online.
<b>Whirlpool Cleaning Systems -</b> Fill-Flush (FFSO) <b>\$590</b> ; Simple Touch (FFE) <b>\$710</b>
<b>Ozonator</b> - bath water purification system (OZONE) <b>\$535</b>

