



Victoria 3

71.25" x 40.75" x 21"

GENERAL SPECIFICATIONS:

Material - Acrylic

Installation - Drop-in (cannot be undermounted)
Not recommended as a tub / shower combination.

Plumbed Weight - 125 lbs / 57 kg

Soaker Weight - 100 lbs / 45 kg

Average Fill - 40 gal to above jet level

Maximum Fill - 80 gal to overflow

NOTE: Filling this tub to the maximum may require an above average size or dedicated water heater.

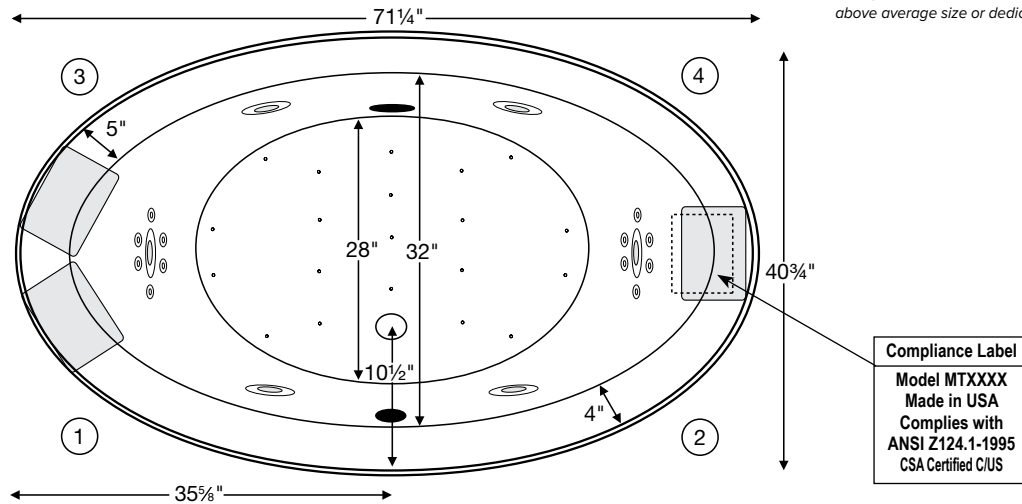

Numbered areas outside of tub represent possible stub-out locations for cleaning systems and Breda valves.
Shown with Air Massage and Ultra Whirlpool Package.

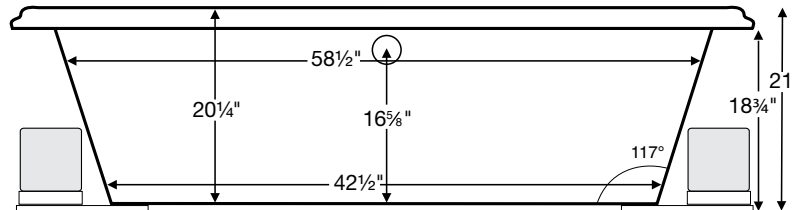

IMPORTANT:
Air baths and tubs with a pre-leveled foam base add 2-3" to overall tub height.

ELECTRICAL COMPONENTS & SPECIFICATIONS		
Required Electrical Service - 110 Volt		
Hydrotherapy Package	Components Included	GFCI
Standard Whirlpool	2-bhp pump	1-15 amp
Ultra Whirlpool	2 2-bhp pumps, inline heater	2-20 amp
Air Massage	heated blower	1-15 amp
Air Massage Elite	heated blower, chromatherapy	1-15 amp
Air Massage with Standard Whirlpool	2-bhp pump, heated blower	2-15 amp
Air Massage with Ultra Whirlpool	2 2-bhp pumps, inline heater, heated blower	2-20 amp
Air Massage Elite with Standard Whirlpool	2-bhp pump, heated blower, chromatherapy	2-15 amp
Air Massage Elite with Ultra Whirlpool	2 2-bhp pumps, inline heater, heated blower, chromatherapy	2-20 amp

For electrical requirements of tub options, see specific options specs
CSA Certified C/US; ANSI Z124.1 for plastic tubs and ANSI 112.19.7 for whirlpool components.

IMPORTANT ORDERING & INSTALLATION INFORMATION:

- Before ordering or installing, please consider future access to equipment.
- Add bedding compound to fully level and support bottom of tub.
- Tubs equipped with an air bath or a pre-leveled foam base are designed to rest on the floor *without* bedding compound, provided the floor is level.
- **Overall tub height is increased by approx. 2-3" when tub is equipped with any air bath package or when pre-leveled foam base or frame system is ordered.**
- Please measure tub **on-site** before building tub decking.
- If you are planning to use a glass enclosure, MTI must be advised when ordering for possible relocation of controls.
- Suction and control locations may vary.
- Specifications and configurations are subject to change without notice.
- Measurements are $\pm 1/2"$ and are subject to change without notice.
- Measurements herein supersede all others published prior to publication date shown below.













See the "Designer Collection Tubs Installation & Operation Manual" included with tub delivery or go to mtibaths.com/support/installation_operation/manuals for all the information necessary to install and operate the tub.

MTI's Customer Service Department is available Monday-Friday 8am-6pm EST at 800-783-8827 or customerservice@mtibaths.com to answer any questions pertaining to ordering or installation.



Packages and Pricing

For more information on any of the following packages, please visit: mtibaths.com/about-mti/therapies-for-wellness/

Hydrotherapy Packages	Package Contents	Part #	MSRP
 Soaker	Soaking bath - no jets	S117	\$2,095
 Stream Bath	6 side vents, 2 end vents, 1-bhp pump	SM117	\$3,945
 Air Massage	20 air jets, heated air blower, pre-leveled foam base (increases overall height 2-3")	AST117	\$4,910
 Air Massage Elite	30 air jets, heated air blower, Chromatherapy LED lighting, Spa Mode (<i>keypad must be remote mounted</i>), pre-leveled foam base (increases overall height 2-3")	AE117	\$6,640
 Stream Bath with Air Massage	6 side vents, 2 end vents, 1-bhp pump, 20 air jets, heated air blower, pre-leveled foam base (increases overall height 2-3")	ASTSM117	\$6,760
 Stream Bath with Air Massage Elite	6 side vents, 2 end vents, 1-bhp pump, 30 air jets, heated air blower, Chromatherapy LED lighting, Spa Mode (<i>keypad must be remote mounted</i>), pre-leveled foam base (increases overall height 2-3")	AESM117	\$8,490
 Standard Whirlpool	6 point-massage jets, 2-bhp pump	P117	\$3,805
 Ultra Whirlpool	6 point-massage jets, 12 micro-jets with Tsubo massage, 2 2-bhp pumps, inline heater, Ozone	P117U	\$6,200
 Air Massage with Standard Whirlpool	6 point-massage jets, 2-bhp pump, 20 air jets, heated air blower, pre-leveled foam base (increases overall height 2-3")	AW117	\$6,485
 Air Massage with Ultra Whirlpool	6 point-massage jets, 12 micro jets with Tsubo massage, 2 2-bhp pumps, inline heater, 20 air jets, heated air blower, Ozone, pre-leveled foam base (increases overall height 2-3")	AU117	\$9,085
 Air Massage Elite with Standard Whirlpool	6 point-massage jets, 2-bhp pump, 30 air jets, heated air blower, Chromatherapy LED lighting, Spa Mode (<i>keypad must be remote mounted</i>), pre-leveled foam base (increases overall height 2-3")	AEAP117	\$8,080
 Air Massage Elite with Ultra Whirlpool	6 point-massage jets, 12 micro-jets with Tsubo massage, 2 2-bhp pumps, inline heater, 30 air jets, heated air blower, Ozone, Chromatherapy LED lighting, Spa Mode (<i>keypad must be remote mounted</i>), pre-leveled foam base (increases overall height 2-3")	AEAP117U	\$10,345

Lead Time - Soakers, Stream Bath and Whirlpool Packages - 5 business days
Air Baths and Combo Packages - 7 business days

NOTES: • Aromatherapy is eliminated for undermount applications
• Air Baths, Pre-Leveled Foam Base or Frame Systems increase overall height by 2-3".

RECOMMENDED SENSORY THERAPIES

SEE NEXT PAGE FOR AN OVERVIEW OF AVAILABLE OPTIONS.



Chromatherapy
Underwater lighting is provided by digitally controlled LEDs. Different colors are thought to have different therapeutic effects.

LE - \$610



Audiotherapy
Stereo H₂O lets you "feel" the music through the bath water. Available with Bluetooth system or transducers with leads to connect to an external system.

STEREOH202 - \$1,135
STEREOBT - \$1,235



Thermotherapy
Radiance uses integrated radiant heat to warm the backrest for neck, shoulders and back. Inline heaters maintain bath water temperature.

RAD100 - \$1,080
HTISOAK - \$750



Microbubbles
For wellness and beauty, billions of the tiniest air bubbles saturate the water with dissolved oxygen to moisturize and soften the skin. Available for soakers and air baths.

MICRO - \$1,745



Options and Pricing

For more information on any of the following options, please visit: mtibaths.com/about-products/tub-options/

Premium Options

NOTE: part codes for all options listed in parenthesis.

Microbubbles - Available on Soakers and Air Baths only (MICRO) \$1,745
Radiance - integrated tub shell heating system (RAD100) \$1,080
Chromatherapy - Included in some hydrotherapy packages underwater LED lighting (LE) \$610
Stereo H₂O -Standard System - includes 4 integrated audio transducers with leads to connect to an external audio source (STEREOH202) \$1,135 Bluetooth System - integrated Bluetooth system allows you to directly connect to an applicable device (STEREOBT) \$1,235

Standard Options

Standard Colors: White (CWH), Bone (CBN), Biscuit (CBS) Color Upgrade: (COL2) \$500 , please call for availability of special colors
Quick Ship - reduces lead time - please call for availability (QSPRI) \$380
Textured, Slip-Resistant Bottom - meets ASTM F-462-1994 (TXBTM) \$75
Virtual Spout - high-flow integrated tub filler (FPMJ) \$310
Inline Heater - included in some hydrotherapy packages For whirlpools or Stream Bath (HTI) \$545 Uses existing pump Soaker or Air Baths (HTISOAK) \$750 Includes a recirculating pump.

Installation Aids

Pre-Leveled Foam Base - for soaker or whirlpools (PLFOAM) \$175

Accessories & Hardware for All Packages

Drain Kits - other finishes also available
Toe-Tap with Round Overflow - Chrome (WOTTC) \$285 Brushed Nickel (WOTTBN) \$290 Polished Nickel (WOTTPN) \$340
Cable Driven - Chrome (WOCD) \$315 Brushed Nickel (WOCDBN) \$385 Polished Nickel (WOCDPN) \$515 Oil-Rubbed Bronze (WOCDOR) \$515
Lift & Turn -Chrome (WOC) \$125 Brushed Nickel (WOBN) \$225
Grab Bars - 9" Curved, set of 2 Acrylic - color-matched with tub standard colors only (GB) \$300 Metal - Chrome (GBMCC), Brushed Nickel (GBMCBN) \$330
Pillows - from \$125 see pillows spec at: mtibaths.com/wp-content/uploads/2016/11/options_pillows.pdf
Teak Bath Mat (TK-MAT3018) \$430 custom sizes also available
Accessories & Cleaning Systems for Whirlpool Packages
Trim Kits - must be ordered at time of purchase; other finishes available Standard Whirlpool - Chrome (TRC) \$235 ; Brushed Nickel (TRBN) \$595 Ultra Whirlpool - Chrome (TRCU) \$320 ; Brushed Nickel (TRBNU) \$815
Pump Upgrade - 3-bhp (PUMP3) \$245
Additional Jet Options see jet options spec at mtibaths.com
Whirlpool Cleaning Systems - Fill-Flush (FFSO) \$590 ; Simple Touch (FFE) \$710
Ozonator - bath water purification system (OZONE) \$535

