



# Victoria 3

## 71.25" x 40.75" x 21"

### GENERAL SPECIFICATIONS:

**Material** - Acrylic

**Installation** - Drop-in (cannot be undermounted)  
*Not recommended as a tub / shower combination.*

**Plumbed Weight** - 125 lbs / 57 kg

**Soaker Weight** - 100 lbs / 45 kg

**Average Fill** - 40 gal to above jet level

**Maximum Fill** - 80 gal to overflow

*NOTE: Filling this tub to the maximum may require an above average size or dedicated water heater.*

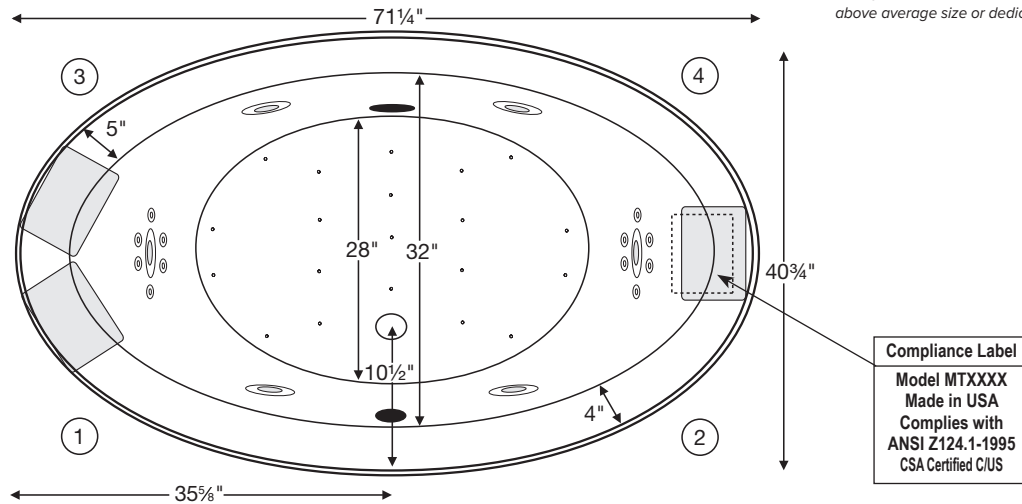

Numbered areas outside of tub represent possible stub-out locations for cleaning systems and Breda valves.  
Shown with Air Massage and Ultra Whirlpool Package.

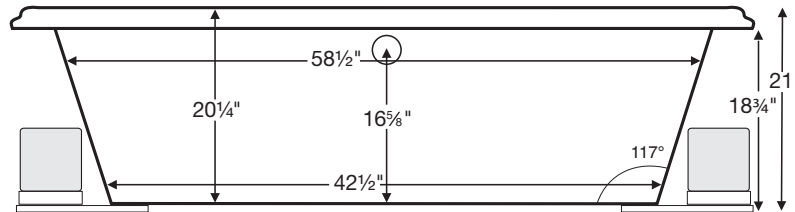

**IMPORTANT:**  
Air baths and tubs with a pre-leveled foam base add 2-3" to overall tub height.

| ELECTRICAL COMPONENTS & SPECIFICATIONS    |  |          |
|---|--|----------|
| Required Electrical Service - 110 Volt    |  |          |
| Hydrotherapy Package                      | Components Included  | GFCI     |
| Standard Whirlpool                        | 2-bhp pump   | 1-15 amp |
| Ultra Whirlpool                           | 2 2-bhp pumps, inline heater                               | 2-20 amp |
| Air Massage                               | heated blower  | 1-15 amp |
| Air Massage Elite                         | heated blower, chromatherapy                               | 1-15 amp |
| Air Massage with Standard Whirlpool       | 2-bhp pump, heated blower                                  | 2-15 amp |
| Air Massage with Ultra Whirlpool          | 2 2-bhp pumps, inline heater, heated blower                | 2-20 amp |
| Air Massage Elite with Standard Whirlpool | 2-bhp pump, heated blower, chromatherapy                   | 2-15 amp |
| Air Massage Elite with Ultra Whirlpool    | 2 2-bhp pumps, inline heater, heated blower, chromatherapy | 2-20 amp |

*For electrical requirements of tub options, see specific options specs*  
CSA Certified C/US; ANSI Z124.1 for plastic tubs and ANSI 112.19.7 for whirlpool components.

### IMPORTANT ORDERING & INSTALLATION INFORMATION:

- Before ordering or installing, please consider future access to equipment.
- Add bedding compound to fully level and support bottom of tub.
- Tubs equipped with an air bath or a pre-leveled foam base are designed to rest on the floor *without* bedding compound, provided the floor is level.
- **Overall tub height is increased by approx. 2-3" when tub is equipped with any air bath package or when pre-leveled foam base or frame system is ordered.**
- Please measure tub **on-site** before building tub decking.
- If you are planning to use a glass enclosure, MTI must be advised when ordering for possible relocation of controls.
- Suction and control locations may vary.
- Specifications and configurations are subject to change without notice.
- Measurements are  $\pm 1/2"$  and are subject to change without notice.
- Measurements herein supersede all others published prior to publication date shown below.













See the "Designer Collection Tubs Installation & Operation Manual" included with tub delivery or go to [mtibaths.com/support/installation\\_operation/manuals](http://mtibaths.com/support/installation_operation/manuals) for all the information necessary to install and operate the tub.

MTI's Customer Service Department is available Monday-Friday 8am-6pm EST at 800-783-8827 or [customerservice@mtibaths.com](mailto:customerservice@mtibaths.com) to answer any questions pertaining to ordering or installation.



### Packages and Pricing

For more information on any of the following packages, please visit: [mtibaths.com/about-mti/therapies-for-wellness/](http://mtibaths.com/about-mti/therapies-for-wellness/)

| Hydrotherapy Packages   | Package Contents  | Part #   | MSRP    |
|---|---|----------|---------|
|  Soaker                                      | Soaking bath - no jets  | S117     | \$2,025 |
|  Stream Bath                                 | 6 side vents, 2 end vents, 1-bhp pump   | SM117    | \$3,820 |
|  Air Massage                                 | 20 air jets, heated air blower, pre-leveled foam base (increases overall height 2-3")   | AST117   | \$4,725 |
|  Air Massage Elite                           | 30 air jets, heated air blower, Chromatherapy LED lighting, Spa Mode ( <i>keypad must be remotely mounted</i> ), pre-leveled foam base (increases overall height 2-3")  | AE117    | \$6,385 |
|  Stream Bath with Air Massage                | 6 side vents, 2 end vents, 1-bhp pump, 20 air jets, heated air blower, pre-leveled foam base (increases overall height 2-3")  | ASTSM117 | \$6,520 |
|  Stream Bath with Air Massage Elite          | 6 side vents, 2 end vents, 1-bhp pump, 30 air jets, heated air blower, Chromatherapy LED lighting, Spa Mode ( <i>keypad must be remotely mounted</i> ), pre-leveled foam base (increases overall height 2-3")   | AESM117  | \$8,180 |
|  Standard Whirlpool                          | 6 point-massage jets, 2-bhp pump  | P117     | \$3,660 |
|  Ultra Whirlpool                             | 6 point-massage jets, 12 micro-jets with Tsubo massage, 2 2-bhp pumps, inline heater, Ozone   | P117U    | \$5,960 |
|  Air Massage with Standard Whirlpool        | 6 point-massage jets, 2-bhp pump, 20 air jets, heated air blower, pre-leveled foam base (increases overall height 2-3")   | AW117    | \$6,235 |
|  Air Massage with Ultra Whirlpool          | 6 point-massage jets, 12 micro jets with Tsubo massage, 2 2-bhp pumps, inline heater, 20 air jets, heated air blower, Ozone, pre-leveled foam base (increases overall height 2-3")  | AU117    | \$8,735 |
|  Air Massage Elite with Standard Whirlpool | 6 point-massage jets, 2-bhp pump, 30 air jets, heated air blower, Chromatherapy LED lighting, Spa Mode ( <i>keypad must be remotely mounted</i> ), pre-leveled foam base (increases overall height 2-3")  | AEAP117  | \$7,770 |
|  Air Massage Elite with Ultra Whirlpool    | 6 point-massage jets, 12 micro-jets with Tsubo massage, 2 2-bhp pumps, inline heater, 30 air jets, heated air blower, Ozone, Chromatherapy LED lighting, Spa Mode ( <i>keypad must be remotely mounted</i> ), pre-leveled foam base (increases overall height 2-3") | AEAP117U | \$9,945 |

**Lead Time** - Soakers, Stream Bath and Whirlpool Packages - 5 business days  
Air Baths and Combo Packages - 7 business days

**NOTES:** • Aromatherapy is eliminated for undermount applications  
• Air Baths, Pre-Leveled Foam Base or Frame Systems increase overall height by 2-3".

RECOMMENDED SENSORY THERAPIES

SEE NEXT PAGE FOR AN OVERVIEW OF AVAILABLE OPTIONS.



**Chromatherapy**  
Underwater lighting is provided by digitally controlled LEDs. Different colors are thought to have different therapeutic effects.

LE - \$590



**Audiotherapy**  
Stereo H<sub>2</sub>O lets you "feel" the music through the bath water. Available with Bluetooth system or transducers with leads to connect to an external system.

STEREOH202 - \$1,100  
STEREOBT - \$1,200



**Thermotherapy**  
Radiance uses integrated radiant heat to warm the backrest for neck, shoulders and back. Inline heaters maintain bath water temperature.

RAD100 - \$1,050  
HTISOAK - \$730



**Microbubbles**  
For wellness and beauty, billions of the tiniest air bubbles saturate the water with dissolved oxygen to moisturize and soften the skin. Available for soakers and air baths.

MICRO - \$1,995



### Options and Pricing

For more information on any of the following options, please visit: [mtibaths.com/about-products/tub-options/](http://mtibaths.com/about-products/tub-options/)

#### Premium Options

NOTE: part codes for all options listed in parenthesis.

|  |
|--|
| <b>Microbubbles</b> - Available on Soakers and Air Baths only<br>(MICRO) <b>\$1,995</b>  |
| <b>Radiance</b> - integrated tub shell heating system<br>(RAD100) <b>\$1,050</b>   |
| <b>Chromatherapy</b> - Included in some hydrotherapy packages<br>underwater LED lighting (LE) <b>\$590</b>   |
| <b>Stereo H<sub>2</sub>O - Standard System</b> - includes 4 integrated audio transducers with leads to connect to an external audio source<br>(STEREOH202) <b>\$1,100</b><br><b>Bluetooth System</b> - integrated Bluetooth system allows you to directly connect to an applicable device<br>(STEREOBT) <b>\$1,200</b> |

#### Standard Options

|   |
|---|
| <b>Standard Colors:</b> White (CWH), Bone (CBN), Biscuit (CBS)<br><b>Color Upgrade:</b> (COL2) <b>\$450</b> , please call for availability of special colors  |
| <b>Quick Ship</b> - reduces lead time - please call for availability<br>(QSPRI) <b>\$370</b>  |
| <b>Textured, Slip-Resistant Bottom</b> - meets ASTM F-462-1994<br>(TXBTM) <b>\$75</b>   |
| <b>Virtual Spout</b> - high-flow integrated tub filler<br>(FPMJ) <b>\$300</b>   |
| <b>Inline Heater</b> - included in some hydrotherapy packages<br>For whirlpools or Stream Bath (HTI) <b>\$530</b><br>Uses existing pump<br>Soaker or Air Baths (HTISOAK) <b>\$730</b><br>Includes a recirculating pump. |

#### Installation Aids

|  |
|--|
| <b>Pre-Levelled Foam Base</b> - for soaker or whirlpools (PLFOAM) <b>\$170</b> |
|--|

#### Accessories & Hardware for All Packages

|   |
|---|
| <b>Drain Kits</b> - other finishes also available   |
| <b>Toe-Tap with Round Overflow</b> -<br>Chrome (WOTTC) <b>\$275</b><br>Brushed Nickel (WOTTBN) <b>\$280</b><br>Polished Nickel (WOTTPN) <b>\$330</b>  |
| <b>Cable Driven</b> -<br>Chrome (WOCD) <b>\$305</b><br>Brushed Nickel (WOCDBN) <b>\$375</b><br>Polished Nickel (WOCDPN) <b>\$500</b><br>Oil-Rubbed Bronze (WOCDOR) <b>\$500</b>   |
| <b>Lift &amp; Turn</b> -Chrome (WOC) <b>\$120</b><br>Brushed Nickel (WOBN) <b>\$220</b>   |
| <b>Grab Bars</b> - 9" Curved, set of 2<br>Acrylic - color-matched with tub standard colors only (GB) <b>\$290</b><br>Metal - Chrome (GBMCC), Brushed Nickel (GBMCBN) <b>\$320</b>   |
| <b>Pillows</b> - from <b>\$120</b> see pillows spec at:<br><a href="http://mtibaths.com/wp-content/uploads/2016/11/options_pillows.pdf">mtibaths.com/wp-content/uploads/2016/11/options_pillows.pdf</a>   |
| <b>Teak Bath Mat</b> (TK-MAT3018) <b>\$410</b> custom sizes also available  |
| <b>Accessories &amp; Cleaning Systems for Whirlpool Packages</b>  |
| <b>Trim Kits</b> - must be ordered at time of purchase; other finishes available<br>Standard Whirlpool - Chrome (TRC) <b>\$230</b> ; Brushed Nickel (TRBN) <b>\$580</b><br>Ultra Whirlpool - Chrome (TRCU) <b>\$310</b> ; Brushed Nickel (TRBNU) <b>\$790</b> |
| <b>Pump Upgrade</b> - 3-bhp (PUMP3) <b>\$240</b>  |
| <b>Additional Jet Options</b> see jet options spec at <a href="http://mtibaths.com">mtibaths.com</a>  |
| <b>Whirlpool Cleaning Systems</b> -<br>Fill-Flush (FFSO) <b>\$575</b> ; Simple Touch (FFE) <b>\$690</b>   |
| <b>Ozonator</b> - bath water purification system (OZONE) <b>\$520</b>   |

