



Features integral skirting and tile flange.

Designer Collection Tubs  
Model # 152

## Cameron 2

### 60" x 30" x 20"

#### GENERAL SPECIFICATIONS:

**Material** - Acrylic

**Installation** - Alcove

**Plumbed Weight** - 130 lbs / 59 kg

**Soaker Weight** - 105 lbs / 48 kg

**Average Fill** - 30 gal to above jet level

**Maximum Fill** - 55 gal to overflow

*NOTE: Filling this tub to the maximum may require an above average size or dedicated water heater.*

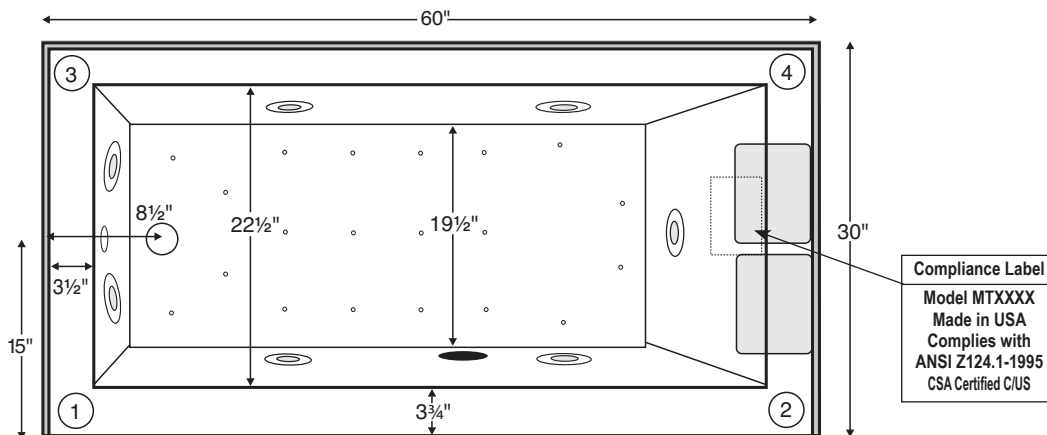

Numbered areas on tub deck represent possible locations to install cleaning systems, faucets and other fixtures.  
Shown with Air Massage and Ultra Whirlpool Package.

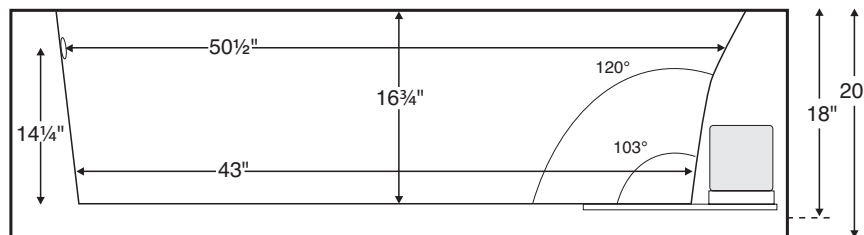

ELECTRICAL COMPONENTS & SPECIFICATIONS		
Required Electrical Service - 110 Volt		
Hydrotherapy Package	Components Included	GFCI
Standard Whirlpool	2-bhp pump	1-15 amp
Ultra Whirlpool	2 2-bhp pumps, inline heater	2-20 amp
Air Massage	heated blower	1-15 amp
Air Massage Elite	heated blower, chromatherapy	1-15 amp
Air Massage with Standard Whirlpool	2-bhp pump, heated blower	2-15 amp
Air Massage with Ultra Whirlpool	2 2-bhp pumps, inline heater, heated blower	2-20 amp
Air Massage Elite with Standard Whirlpool	2-bhp pump, heated blower, chromatherapy	2-15 amp
Air Massage Elite with Ultra Whirlpool	2 2-bhp pumps, inline heater, heated blower, chromatherapy	2-20 amp

*For electrical requirements of tub options, see specific options specs*  
CSA Certified C/US; ANSI Z124.1 for plastic tubs and ANSI 112.19.7 for whirlpool components.

#### IMPORTANT ORDERING & INSTALLATION INFORMATION:

- Before ordering or installing, please consider future access to equipment.
- Cameron includes integral front skirting, tile flange on 3 sides and a pre-leveled foam base to facilitate the installation process.
- Tub is available with a left- or right-hand drain location. Must specify on order.
- Overall standard tub height is 20", but can be reduced by as low as 18" ONLY when ordered as a soaker. Must specify on order.
- Skirting is non-removable and provides no access. Must have end access for servicing of equipment.
- If you plan to use a glass enclosure, MTI must be advised when ordering for possible relocation of systems controls.
- Suction and control locations may vary.
- Specifications and configurations are subject to change without notice.
- Measurements are  $\pm 1/2"$  and are subject to change without notice.
- Measurements herein supersede all others published prior to publication date shown below.













See the "Designer Collection Tubs Installation & Operation Manual" included with tub delivery or go to [mtibaths.com/support/installation\\_operation/manuals](http://mtibaths.com/support/installation_operation/manuals) for all the information necessary to install and operate the tub.

MTI's Customer Service Department is available Monday-Friday 8am-6pm EST at 800-783-8827 or [customerservice@mtibaths.com](mailto:customerservice@mtibaths.com) to answer any questions pertaining to ordering or installation.



### Packages and Pricing

For more information on any of the following packages, please visit: [mtibaths.com/about-mti/therapies-for-wellness/](http://mtibaths.com/about-mti/therapies-for-wellness/)

Hydrotherapy Packages	Package Contents	Part #	MSRP
 Soaker	Soaking bath - no jets; features integral skirting (no front access), integral tile flange, pre-leveled foam base <b>Note: Overall tub height can be reduced by 2" for soakers only. Must specify on order.</b>	<b>S152</b>	<b>\$1,680</b>
 Stream Bath	6 side vents, 2 end vents, 1-bhp pump integral skirting (no front access), integral tile flange, pre-leveled foam base	<b>SM152</b>	<b>\$3,475</b>
 Air Massage	20 air jets, heated air blower, Aromatherapy, integral skirting (no front access), integral tile flange, pre-leveled foam base	<b>AST152</b>	<b>\$4,380</b>
 Air Massage Elite	30 air jets, heated air blower, Aromatherapy, Chromatherapy LED lighting, Spa Mode, integral skirting (no front access), integral tile flange, pre-leveled foam base	<b>AE152</b>	<b>\$6,040</b>
 Stream Bath with Air Massage	6 side vents, 2 end vents, 1-bhp pump, 20 air jets, heated air blower, Aromatherapy, integral skirting (no front access), integral tile flange, pre-leveled foam base	<b>ASTSM152</b>	<b>\$6,175</b>
 Stream Bath with Air Massage Elite	6 side vents, 2 end vents, 1-bhp pump, 30 air jets, heated air blower, Aromatherapy, Chromatherapy LED lighting, Spa Mode, integral skirting (no front access), integral tile flange, pre-leveled foam base	<b>AESM152</b>	<b>\$7,835</b>
 Standard Whirlpool	5 point-massage jets, 2-bhp pump, integral skirting (no front access), integral tile flange, pre-leveled foam base	<b>P152</b>	<b>\$3,255</b>
 Ultra Whirlpool	7 point-massage jets, 2-bhp pump, inline heater, Ozone, integral skirting (no front access), integral tile flange, pre-leveled foam base	<b>P152U</b>	<b>\$4,425</b>
 Air Massage with Standard Whirlpool	5 point-massage jets, 2-bhp pump, 20 air jets, heated air blower, Aromatherapy, integral skirting (no front access), integral tile flange, pre-leveled foam base	<b>AW152</b>	<b>\$5,925</b>
 Air Massage with Ultra Whirlpool	7 point-massage jets, 2-bhp pump, inline heater, 20 air jets, heated air blower, Aromatherapy, Ozone, integral skirting (no front access), integral tile flange, pre-leveled foam base	<b>AU152</b>	<b>\$6,785</b>
 Air Massage Elite with Standard Whirlpool	5 point-massage jets, 2-bhp pump, 30 air jets, heated air blower, Aromatherapy, Chromatherapy LED lighting, Spa Mode, integral skirting (no front access), integral tile flange, pre-leveled foam base	<b>AEAP152</b>	<b>\$7,290</b>
 Air Massage Elite with Ultra Whirlpool	7 point-massage jets, 2-bhp pump, inline heater, 30 air jets, heated air blower, Aromatherapy, Chromatherapy LED lighting, Spa Mode, Ozone integral skirting (no front access), integral tile flange, pre-leveled foam base	<b>AEAP152U</b>	<b>\$8,215</b>

**Lead Time** - Soakers, Stream Bath and Whirlpool Packages - 5 business days  
Air Baths and Combo Packages - 7 business days

**NOTES:** • Aromatherapy is eliminated for undermount applications  
• Air Baths, Pre-Leveled Foam Base or Frame Systems increase overall height by 2-3".

#### RECOMMENDED SENSORY THERAPIES

SEE NEXT PAGE FOR AN OVERVIEW OF AVAILABLE OPTIONS.



**Chromatherapy**  
Underwater lighting is provided by digitally controlled LEDs. Different colors are thought to have different therapeutic effects.

LE - \$590



**Audiotherapy**  
Stereo H<sub>2</sub>O lets you "feel" the music through the bath water. Available with Bluetooth system or transducers with leads to connect to an external system.

STEREOH202 - \$1,100  
STEREOBT - \$1,200



**Thermotherapy**  
Radiance uses integrated radiant heat to warm the backrest for neck, shoulders and back. Inline heaters maintain bath water temperature.

RAD100 - \$1,050  
HTISOAK - \$730



**Microbubbles**  
For wellness and beauty, billions of the tiniest air bubbles saturate the water with dissolved oxygen to moisturize and soften the skin. Available for soakers and air baths.

MICRO - \$1,995



### Options and Pricing

For more information on any of the following options, please visit: [mtibaths.com/about-products/tub-options/](http://mtibaths.com/about-products/tub-options/)

#### Premium Options

NOTE: part codes for all options listed in parenthesis.

**Microbubbles** - Available on Soakers and Air Baths only  
(MICRO) **\$1,995**

**Radiance** - integrated tub shell heating system  
(RAD100) **\$1,050**

**Chromatherapy** - Included in some hydrotherapy packages  
underwater LED lighting (LE) **\$590**

**Stereo H<sub>2</sub>O - Standard System** - includes 4 integrated audio transducers with leads to connect to an external audio source  
(STEREOH202) **\$1,100**  
**Bluetooth System** - integrated Bluetooth system allows you to directly connect to an applicable device  
(STEREOBT) **\$1,200**

#### Standard Options

**Standard Colors:** White (CWH), Bone (CBN), Biscuit (CBS)  
**Color Upgrade:** (COL2) **\$450**, please call for availability of special colors

**Quick Ship** - reduces lead time - please call for availability  
(QSPRI) **\$370**

**Textured, Slip-Resistant Bottom** - meets ASTM F-462-1994  
(TXBTM) **\$75**

**Virtual Spout** - high-flow integrated tub filler  
(FPMJ) **\$300**

**Inline Heater** - included in some hydrotherapy packages  
For whirlpools or Stream Bath (HTI) **\$530**  
Uses existing pump  
Soaker or Air Baths (HTISOAK) **\$730**  
Includes a recirculating pump.

#### Accessories & Hardware for All Packages

**Drain Kits** - other finishes also available

##### Toe-Tap with Slim-Line Integrated Overflow

Choose from: Chrome (SLOT C), Brushed Nickel (SLOTBN),  
Polished Nickel (SLOT PN) or White (SLOTWH) **\$380**

##### Toe-Tap with Rectangular Overflow -

Chrome (WOTRC) **\$275**  
Brushed Nickel (WOTRBN) **\$280**  
White (WOTRW) **\$280**

##### Toe-Tap with Round Overflow -

Chrome (WOTTC) **\$275**  
Brushed Nickel (WOTTBN) **\$280**  
Polished Nickel (WOTTPN) **\$330**

##### Cable Driven -

Chrome (WOCD) **\$305**  
Brushed Nickel (WOCDBN) **\$375**  
Polished Nickel (WOCDPN) **\$500**  
Oil-Rubbed Bronze (WOCDOR) **\$500**

##### Lift & Turn - Chrome (WOC) **\$120**

Brushed Nickel (WOBN) **\$220**

##### Grab Bars - 9" Curved, set of 2

Acrylic - color-matched with tub  
standard colors only (GB) **\$290**  
Metal - Chrome (GBMCC), Brushed Nickel (GBMCBN) **\$320**

##### Pillows - from **\$120** see pillows spec at:

[mtibaths.com/wp-content/uploads/2016/11/options\\_pillows.pdf](http://mtibaths.com/wp-content/uploads/2016/11/options_pillows.pdf)

##### Teak Tub Tray - Slatted (TK-TRAY1) or Solid (TK-TRAY2) **\$395**

##### Teak Bath Mat (TK-MAT3018) **\$410** custom sizes also available

#### Accessories & Cleaning Systems for Whirlpool Packages

**Trim Kits** - must be ordered at time of purchase; other finishes available  
Standard Whirlpool - Chrome (TRC) **\$230**; Brushed Nickel (TRBN) **\$580**  
Ultra Whirlpool - Chrome (TRCU) **\$310**; Brushed Nickel (TRBNU) **\$790**

##### Pump Upgrade - 3-bhp (PUMP3) **\$240**

##### Additional Jet Options see jet options spec at [mtibaths.com](http://mtibaths.com)

##### Whirlpool Cleaning Systems -

Fill-Flush (FFSO) **\$575**; Simple Touch (FFE) **\$690**

##### Ozonator - bath water purification system (OZONE) **\$520**

