



Features integral skirting and tile flange.

Designer Collection Tubs
Model # 153

Cameron 3

66" x 32" x 20.5"

GENERAL SPECIFICATIONS:

Material - Acrylic

Installation - Alcove

Plumbed Weight - 140 lbs / 64 kg

Soaker Weight - 115 lbs / 52 kg

Average Fill - 40 gal to above jet level

Maximum Fill - 67 gal to overflow

NOTE: Filling this tub to the maximum may require an above average size or dedicated water heater.

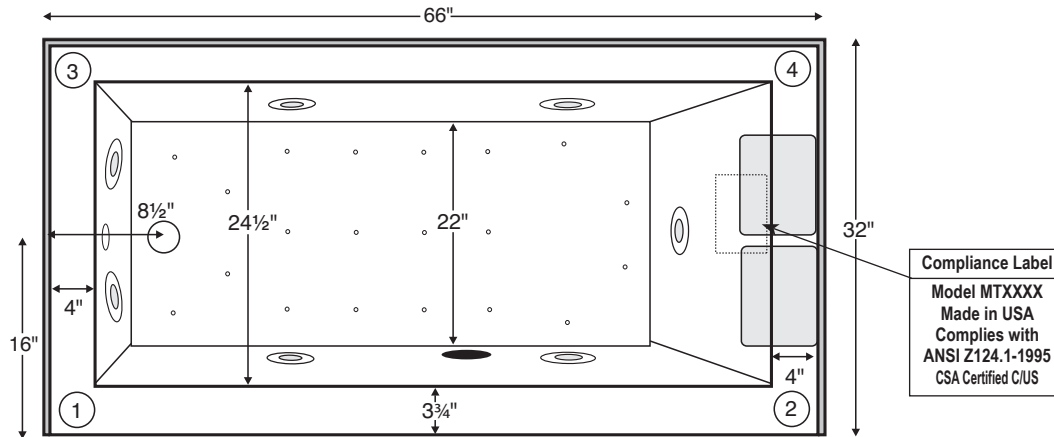

Numbered areas on tub deck represent possible locations to install cleaning systems, faucets and other fixtures.
Shown with Air Massage and Ultra Whirlpool Package.

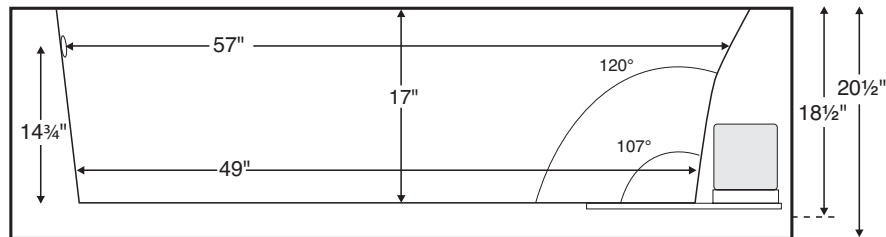

ELECTRICAL COMPONENTS & SPECIFICATIONS		
Required Electrical Service - 110 Volt		
Hydrotherapy Package	Components Included	GFCI
Standard Whirlpool	2-bhp pump	1-15 amp
Ultra Whirlpool	2 2-bhp pumps, inline heater	2-20 amp
Air Massage	heated blower	1-15 amp
Air Massage Elite	heated blower, chromatherapy	1-15 amp
Air Massage with Standard Whirlpool	2-bhp pump, heated blower	2-15 amp
Air Massage with Ultra Whirlpool	2 2-bhp pumps, inline heater, heated blower	2-20 amp
Air Massage Elite with Standard Whirlpool	2-bhp pump, heated blower, chromatherapy	2-15 amp
Air Massage Elite with Ultra Whirlpool	2 2-bhp pumps, inline heater, heated blower, chromatherapy	2-20 amp

For electrical requirements of tub options, see specific options specs
CSA Certified C/US; ANSI Z124.1 for plastic tubs and ANSI 112.19.7 for whirlpool components.

IMPORTANT ORDERING & INSTALLATION INFORMATION:

- Before ordering or installing, please consider future access to equipment.
- Cameron includes integral front skirting, tile flange on 3 sides and a pre-leveled foam base to facilitate the installation process.
- Tub is available with a left- or right-hand drain location. Must specify on order.
- Overall standard tub height is 20.5", but can be reduced by as low as 18.5" ONLY when ordered as a soaker. Must specify on order.
- Skirting is non-removable and provides no access. Must have end access for servicing of equipment.
- If you plan to use a glass enclosure, MTI must be advised when ordering for possible relocation of systems controls.
- Suction and control locations may vary.
- Specifications and configurations are subject to change without notice.
- Measurements are $\pm 1/2"$ and are subject to change without notice.
- Measurements herein supersede all others published prior to publication date shown below.













See the "Designer Collection Tubs Installation & Operation Manual" included with tub delivery or go to mtibaths.com/support/installation_operation/manuals for all the information necessary to install and operate the tub.

MTI's Customer Service Department is available Monday-Friday 8am-6pm EST at 800-783-8827 or customerservice@mtibaths.com to answer any questions pertaining to ordering or installation.



Packages and Pricing

For more information on any of the following packages, please visit: mtibaths.com/about-mti/therapies-for-wellness/

Hydrotherapy Packages	Package Contents	Part #	MSRP
 Soaker	Soaking bath - no jets; features integral skirting (no front access), integral tile flange, pre-leveled foam base Note: Overall tub height can be reduced by 2" for soakers only. Must specify on order.	S153	\$1,810
 Stream Bath	6 side vents, 2 end vents, 1-bhp pump integral skirting (no front access), integral tile flange, pre-leveled foam base	SM153	\$3,605
 Air Massage	20 air jets, heated air blower, Aromatherapy, integral skirting (no front access), integral tile flange, pre-leveled foam base	AST153	\$4,510
 Air Massage Elite	30 air jets, heated air blower, Aromatherapy, Chromatherapy LED lighting, Spa Mode, integral skirting (no front access), integral tile flange, pre-leveled foam base	AE153	\$6,170
 Stream Bath with Air Massage	6 side vents, 2 end vents, 1-bhp pump, 20 air jets, heated air blower, Aromatherapy, integral skirting (no front access), integral tile flange, pre-leveled foam base	ASTSM153	\$6,305
 Stream Bath with Air Massage Elite	6 side vents, 2 end vents, 1-bhp pump, 30 air jets, heated air blower, Aromatherapy, Chromatherapy LED lighting, Spa Mode, integral skirting (no front access), integral tile flange, pre-leveled foam base	AESM153	\$7,965
 Standard Whirlpool	5 point-massage jets, 2-bhp pump, integral skirting (no front access), integral tile flange, pre-leveled foam base	P153	\$3,390
 Ultra Whirlpool	7 point-massage jets, 2-bhp pump, inline heater, Ozone, integral skirting (no front access), integral tile flange, pre-leveled foam base	P153U	\$4,560
 Air Massage with Standard Whirlpool	5 point-massage jets, 2-bhp pump, 20 air jets, heated air blower, Aromatherapy, integral skirting (no front access), integral tile flange, pre-leveled foam base	AW153	\$6,060
 Air Massage with Ultra Whirlpool	7 point-massage jets, 2-bhp pump, inline heater, 20 air jets, heated air blower, Aromatherapy, Ozone, integral skirting (no front access), integral tile flange, pre-leveled foam base	AU153	\$6,910
 Air Massage Elite with Standard Whirlpool	5 point-massage jets, 2-bhp pump, 30 air jets, heated air blower, Aromatherapy, Chromatherapy LED lighting, Spa Mode, integral skirting (no front access), integral tile flange, pre-leveled foam base	AEAP153	\$7,425
 Air Massage Elite with Ultra Whirlpool	7 point-massage jets, 2-bhp pump, inline heater, 30 air jets, heated air blower, Aromatherapy, Chromatherapy LED lighting, Spa Mode, Ozone integral skirting (no front access), integral tile flange, pre-leveled foam base	AEAP153U	\$8,350

Lead Time - Soakers, Stream Bath and Whirlpool Packages - 5 business days
Air Baths and Combo Packages - 7 business days

NOTES: • Aromatherapy is eliminated for undermount applications
• Air Baths, Pre-Leveled Foam Base or Frame Systems increase overall height by 2-3".

RECOMMENDED SENSORY THERAPIES

SEE NEXT PAGE FOR AN OVERVIEW OF AVAILABLE OPTIONS.



Chromatherapy
Underwater lighting is provided by digitally controlled LEDs. Different colors are thought to have different therapeutic effects.

LE - \$590



Audiotherapy
Stereo H₂O lets you "feel" the music through the bath water. Available with Bluetooth system or transducers with leads to connect to an external system.

STEREOH202 - \$1,100
STEREOBT - \$1,200



Thermaltherapy
Radiance uses integrated radiant heat to warm the backrest for neck, shoulders and back. Inline heaters maintain bath water temperature.

RAD100 - \$1,050
HTISOAK - \$730



Microbubbles
For wellness and beauty, billions of the tiniest air bubbles saturate the water with dissolved oxygen to moisturize and soften the skin. Available for soakers and air baths.

MICRO - \$1,995



Options and Pricing

For more information on any of the following options, please visit: mtibaths.com/about-products/tub-options/

Premium Options

NOTE: part codes for all options listed in parenthesis.

Microbubbles - Available on Soakers and Air Baths only (MICRO) \$1,995
Radiance - integrated tub shell heating system (RAD100) \$1,050
Chromatherapy - Included in some hydrotherapy packages underwater LED lighting (LE) \$590
Stereo H₂O - Standard System - includes 4 integrated audio transducers with leads to connect to an external audio source (STEREOH202) \$1,100 Bluetooth System - integrated Bluetooth system allows you to directly connect to an applicable device (STEREOBT) \$1,200
Standard Options
Standard Colors: White (CWH), Bone (CBN), Biscuit (CBS) Color Upgrade: (COL2) \$450 , please call for availability of special colors
Quick Ship - reduces lead time - please call for availability (QSPRI) \$370
Textured, Slip-Resistant Bottom - meets ASTM F462-1994 (TXBTM) \$75
Virtual Spout - high-flow integrated tub filler (FPMJ) \$300
Inline Heater - included in some hydrotherapy packages For whirlpools or Stream Bath (HTI) \$530 Uses existing pump Soaker or Air Baths (HTISOAK) \$730 Includes a recirculating pump.

Accessories & Hardware for All Packages

Drain Kits - other finishes also available
Toe-Tap with Slim-Line Integrated Overflow Choose from: Chrome (SLOT C), Brushed Nickel (SLOTBN), Polished Nickel (SLOT PN) or White (SLOTWH) \$380
Toe-Tap with Rectangular Overflow - Chrome (WOTRC) \$275 Brushed Nickel (WOTRBN) \$280 White (WOTRW) \$280
Toe-Tap with Round Overflow - Chrome (WOTTC) \$275 Brushed Nickel (WOTTRBN) \$280 Polished Nickel (WOTTPN) \$330
Cable Driven - Chrome (WOCD) \$305 Brushed Nickel (WOCDBN) \$375 Polished Nickel (WOCDPN) \$500 Oil-Rubbed Bronze (WOCBOR) \$500
Lift & Turn - Chrome (WOC) \$120 Brushed Nickel (WOBN) \$220
Grab Bars - 9" Curved, set of 2 Acrylic - color-matched with tub standard colors only (GB) \$290 Metal - Chrome (GBMCC), Brushed Nickel (GBMCBN) \$320
Pillows - from \$120 see pillows spec at: mtibaths.com/wp-content/uploads/2016/11/options_pillows.pdf
Teak Tub Tray - Slatted (TK-TRAY1) or Solid (TK-TRAY2) \$395
Teak Bath Mat (TK-MAT3018) \$410 custom sizes also available
Accessories & Cleaning Systems for Whirlpool Packages
Trim Kits - must be ordered at time of purchase; other finishes available Standard Whirlpool - Chrome (TRC) \$230 ; Brushed Nickel (TRBN) \$580 Ultra Whirlpool - Chrome (TRCU) \$310 ; Brushed Nickel (TRBNU) \$790
Pump Upgrade - 3-bhp (PUMP3) \$240
Additional Jet Options see jet options spec at mtibaths.com
Whirlpool Cleaning Systems - Fill-Flush (FFSO) \$575 ; Simple Touch (FFE) \$690
Ozonator - bath water purification system (OZONE) \$520

