



Features integral skirting and tile flange.

# Cameron 4

## 60" x 30.5" x 18"

**GENERAL SPECIFICATIONS:**

- Material** - Acrylic
- Installation** - Alcove
- Plumbed Weight** - 125 lbs / 59 kg
- Soaker Weight** - 100 lbs / 48 kg
- Average Fill** - 35 gal to above jet level
- Maximum Fill** - 45 gal to overflow

*NOTE: Filling this tub to the maximum may require an above average size or dedicated water heater.*

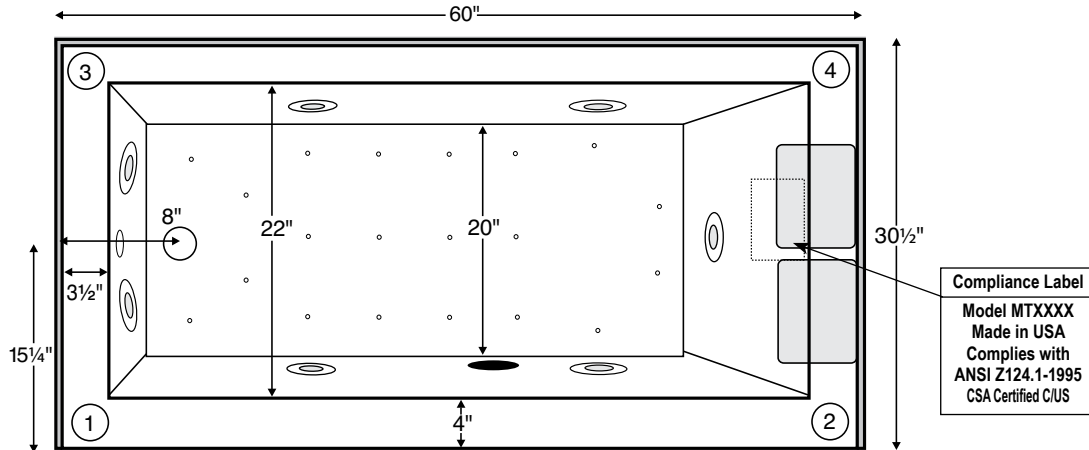

Numbered areas on tub deck represent possible locations to install cleaning systems, faucets and other fixtures.  
Shown with Air Massage and Ultra Whirlpool Package.

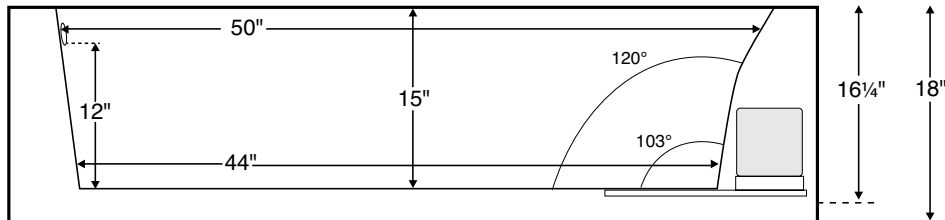

ELECTRICAL COMPONENTS & SPECIFICATIONS		
Required Electrical Service - 110 Volt		
Hydrotherapy Package	Components Included	GFCI
Standard Whirlpool	2-bhp pump	1-15 amp
Ultra Whirlpool	2 2-bhp pumps, inline heater	2-20 amp
Air Massage	heated blower	1-15 amp
Air Massage Elite	heated blower, chromatherapy	1-15 amp
Air Massage with Standard Whirlpool	2-bhp pump, heated blower	2-15 amp
Air Massage with Ultra Whirlpool	2 2-bhp pumps, inline heater, heated blower	2-20 amp
Air Massage Elite with Standard Whirlpool	2-bhp pump, heated blower, chromatherapy	2-15 amp
Air Massage Elite with Ultra Whirlpool	2 2-bhp pumps, inline heater, heated blower, chromatherapy	2-20 amp

*For electrical requirements of tub options, see specific options specs*  
CSA Certified C/US; ANSI Z124.1 for plastic tubs and ANSI 112.19.7 for whirlpool components.

**IMPORTANT ORDERING & INSTALLATION INFORMATION:**

- Before ordering or installing, please consider future access to equipment.
- Cameron includes integral front skirting, tile flange on 3 sides and a pre-leveled foam base to facilitate the installation process.
- Tub is available with a left- or right-hand drain location. Must specify on order.
- Overall standard tub height is 18", but can be reduced by as low as 16.25" ONLY when ordered as a soaker. Must specify on order.
- Skirting is non-removable and provides no access. Must have end access for servicing of equipment.
- If you plan to use a glass enclosure, MTI must be advised when ordering for possible relocation of systems controls.
- Suction and control locations may vary.
- Specifications and configurations are subject to change without notice.
- Measurements are ±1/2" and are subject to change without notice.
- Measurements herein supersede all others published prior to publication date shown below.













See the "Designer Collection Tubs Installation & Operation Manual" included with tub delivery or go to [mtibaths.com/support/installation\\_operation/manuals](http://mtibaths.com/support/installation_operation/manuals) for all the information necessary to install and operate the tub.

MTI's Customer Service Department is available Monday-Friday 8am-6pm EST at 800-783-8827 or [customerservice@mtibaths.com](mailto:customerservice@mtibaths.com) to answer any questions pertaining to ordering or installation.



### Packages and Pricing

For more information on any of the following packages, please visit: [mtibaths.com/about-mti/therapies-for-wellness/](http://mtibaths.com/about-mti/therapies-for-wellness/)

Hydrotherapy Packages	Package Contents	Part #	MSRP
 Soaker	Soaking bath - no jets; features integral skirting (no front access), integral tile flange, pre-leveled foam base <b>Note: Overall tub height can be reduced by 1.75" for soakers only. Must specify on order.</b>	<b>S154</b>	<b>\$1,740</b>
 Stream Bath	6 side vents, 2 end vents, 1-bhp pump integral skirting (no front access), integral tile flange, pre-leveled foam base	<b>SM154</b>	<b>\$3,590</b>
 Air Massage	20 air jets, heated air blower, Aromatherapy, integral skirting (no front access), integral tile flange, pre-leveled foam base	<b>AST154</b>	<b>\$4,555</b>
 Air Massage Elite	30 air jets, heated air blower, Aromatherapy, Chromatherapy LED lighting, Spa Mode, integral skirting (no front access), integral tile flange, pre-leveled foam base	<b>AE154</b>	<b>\$6,285</b>
 Stream Bath with Air Massage	6 side vents, 2 end vents, 1-bhp pump, 20 air jets, heated air blower, Aromatherapy, integral skirting (no front access), integral tile flange, pre-leveled foam base	<b>ASTSM154</b>	<b>\$6,405</b>
 Stream Bath with Air Massage Elite	6 side vents, 2 end vents, 1-bhp pump, 30 air jets, heated air blower, Aromatherapy, Chromatherapy LED lighting, Spa Mode, integral skirting (no front access), integral tile flange, pre-leveled foam base	<b>AESM154</b>	<b>\$8,135</b>
 Standard Whirlpool	5 point-massage jets, 2-bhp pump, integral skirting (no front access), integral tile flange, pre-leveled foam base	<b>P154</b>	<b>\$3,385</b>
 Ultra Whirlpool	7 point-massage jets, 2-bhp pump, inline heater, Ozone, integral skirting (no front access), integral tile flange, pre-leveled foam base	<b>P154U</b>	<b>\$4,600</b>
 Air Massage with Standard Whirlpool	5 point-massage jets, 2-bhp pump, 20 air jets, heated air blower, Aromatherapy, integral skirting (no front access), integral tile flange, pre-leveled foam base	<b>AW154</b>	<b>\$6,160</b>
 Air Massage with Ultra Whirlpool	7 point-massage jets, 2-bhp pump, inline heater, 20 air jets, heated air blower, Aromatherapy, Ozone, integral skirting (no front access), integral tile flange, pre-leveled foam base	<b>AU154</b>	<b>\$7,055</b>
 Air Massage Elite with Standard Whirlpool	5 point-massage jets, 2-bhp pump, 30 air jets, heated air blower, Aromatherapy, Chromatherapy LED lighting, Spa Mode, integral skirting (no front access), integral tile flange, pre-leveled foam base	<b>AEAP154</b>	<b>\$7,580</b>
 Air Massage Elite with Ultra Whirlpool	7 point-massage jets, 2-bhp pump, inline heater, 30 air jets, heated air blower, Aromatherapy, Chromatherapy LED lighting, Spa Mode, Ozone integral skirting (no front access), integral tile flange, pre-leveled foam base	<b>AEAP154U</b>	<b>\$8,545</b>

**Lead Time** - Soakers, Stream Bath and Whirlpool Packages - 5 business days  
Air Baths and Combo Packages - 7 business days

**NOTES:** • Aromatherapy is eliminated for undermount applications  
• Air Baths, Pre-Leveled Foam Base or Frame Systems increase overall height by 2-3".

RECOMMENDED SENSORY THERAPIES

SEE NEXT PAGE FOR AN OVERVIEW OF AVAILABLE OPTIONS.



**Chromatherapy**  
Underwater lighting is provided by digitally controlled LEDs. Different colors are thought to have different therapeutic effects.

LE - \$610



**Audiotherapy**  
Stereo H<sub>2</sub>O lets you "feel" the music through the bath water. Available with Bluetooth system or transducers with leads to connect to an external system.

STEREOH202 - \$1,135  
STEREOBT - \$1,235



**Thermaltherapy**  
Radiance uses integrated radiant heat to warm the backrest for neck, shoulders and back. Inline heaters maintain bath water temperature.

RAD100 - \$1,080  
HTISOAK - \$750



**Microbubbles**  
For wellness and beauty, billions of the tiniest air bubbles saturate the water with dissolved oxygen to moisturize and soften the skin. Available for soakers and air baths.

MICRO - \$1,745



### Options and Pricing

For more information on any of the following options, please visit: [mtibaths.com/about-products/tub-options/](http://mtibaths.com/about-products/tub-options/)

#### Premium Options

NOTE: part codes for all options listed in parenthesis.

**Microbubbles** - Available on Soakers and Air Baths only  
(MICRO) **\$1,745**

**Radiance** - integrated tub shell heating system  
(RAD100) **\$1,080**

**Chromatherapy** - Included in some hydrotherapy packages  
underwater LED lighting (LE) **\$610**

**Stereo H<sub>2</sub>O - Standard System** - includes 4 integrated audio transducers with leads to connect to an external audio source  
(STEREOH202) **\$1,135**  
**Bluetooth System** - integrated Bluetooth system allows you to directly connect to an applicable device  
(STEREOBT) **\$1,235**

#### Standard Options

**Standard Colors:** White (CWH), Bone (CBN), Biscuit (CBS)  
**Color Upgrade:** (COL2) **\$500**, please call for availability of special colors

**Quick Ship** - reduces lead time - please call for availability  
(QSPRI) **\$380**

**Textured, Slip-Resistant Bottom** - meets ASTM F462-1994  
(TXBTM) **\$75**

**Virtual Spout** - high-flow integrated tub filler  
(FPMJ) **\$310**

**Inline Heater** - included in some hydrotherapy packages  
For whirlpools or Stream Bath (HTI) **\$545**  
Uses existing pump  
Soaker or Air Baths (HTISOAK) **\$750**  
Includes a recirculating pump.

#### Accessories & Hardware for All Packages

**Drain Kits** - other finishes also available

##### Toe-Tap with Slim-Line Integrated Overflow

Choose from: Chrome (SLOT C), Brushed Nickel (SLOTBN),  
Polished Nickel (SLOT PN) or White (SLOTWH) **\$390**

##### Toe-Tap with Rectangular Overflow -

Chrome (WOTRC) **\$285**  
Brushed Nickel (WOTRBN) **\$290**  
White (WOTRW) **\$290**

##### Toe-Tap with Round Overflow -

Chrome (WOTTC) **\$285**  
Brushed Nickel (WOTTBN) **\$290**  
Polished Nickel (WOTTPN) **\$340**

##### Cable Driven -

Chrome (WOCD) **\$315**  
Brushed Nickel (WOCDBN) **\$385**  
Polished Nickel (WOCDPN) **\$515**  
Oil-Rubbed Bronze (WOCBOR) **\$515**

##### Lift & Turn - Chrome (WOC) **\$125**

Brushed Nickel (WOBN) **\$225**

##### Grab Bars - 9" Curved, set of 2

Acrylic - color-matched with tub  
standard colors only (GB) **\$300**  
Metal - Chrome (GBMCC), Brushed Nickel (GBMCBN) **\$330**

##### Pillows - from **\$125** see pillows spec at:

[mtibaths.com/wp-content/uploads/2016/11/options\\_pillows.pdf](http://mtibaths.com/wp-content/uploads/2016/11/options_pillows.pdf)

##### Teak Tub Tray - Slatted (TK-TRAY1) or Solid (TK-TRAY2) **\$415**

##### Teak Bath Mat (TK-MAT3018) **\$430** custom sizes also available

#### Accessories & Cleaning Systems for Whirlpool Packages

**Trim Kits** - must be ordered at time of purchase; other finishes available  
Standard Whirlpool - Chrome (TRC) **\$235**; Brushed Nickel (TRBN) **\$595**  
Ultra Whirlpool - Chrome (TRCU) **\$320**; Brushed Nickel (TRBNU) **\$815**

##### Pump Upgrade - 3-bhp (PUMP3) **\$245**

##### Additional Jet Options see jet options spec at [mtibaths.com](http://mtibaths.com)

##### Whirlpool Cleaning Systems -

Fill-Flush (FFSO) **\$590**; Simple Touch (FFE) **\$710**

##### Ozonator - bath water purification system (OZONE) **\$535**

