

Melinda 7

66.5" x 35.5" x 21.5"



GENERAL SPECIFICATIONS:

Material - Acrylic

Installation - Drop-in or Undermount

Not recommended as a tub / shower combination.

Plumbed Weight - 144 lbs / 65 kg

Soaker Weight - 100 lbs / 55 kg

Average Fill - 35 gal to above jet level

Maximum Fill - 81 gal to overflow

NOTE: Filling this tub to the maximum may require an above average size or dedicated water heater.

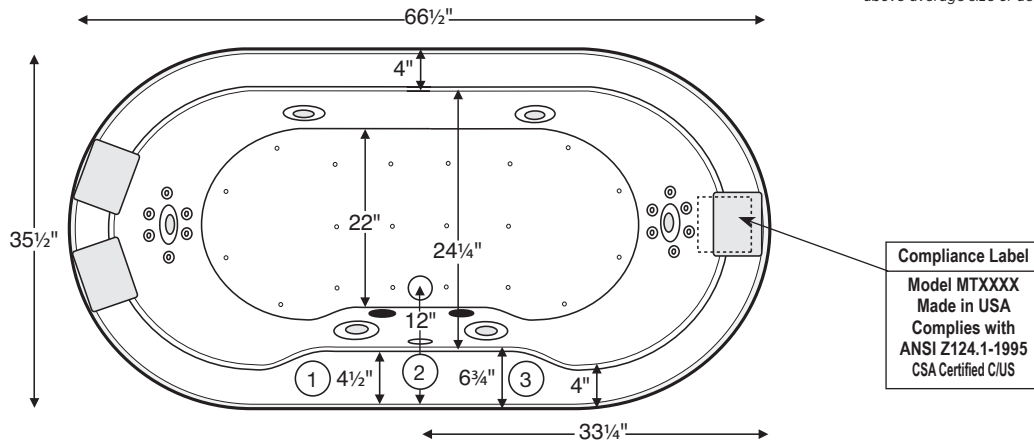

Numbered areas on tub deck represent possible locations to install cleaning systems, faucets and other fixtures.
Shown with Air Massage and Ultra Whirlpool Package.

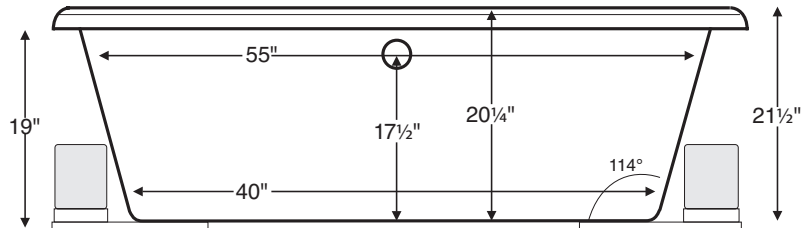

IMPORTANT:
Air baths and tubs with a pre-leveled foam base add 2-3" to overall tub height.

ELECTRICAL COMPONENTS & SPECIFICATIONS		
Required Electrical Service - 110 Volt		
Hydrotherapy Package	Components Included	GFCI
Standard Whirlpool	2-bhp pump	1-15 amp
Ultra Whirlpool	2 2-bhp pumps, inline heater	2-20 amp
Air Massage	heated blower	1-15 amp
Air Massage Elite	heated blower, chromatherapy	1-15 amp
Air Massage with Standard Whirlpool	2-bhp pump, heated blower	2-15 amp
Air Massage with Ultra Whirlpool	2 2-bhp pumps, inline heater, heated blower	2-20 amp
Air Massage Elite with Standard Whirlpool	2-bhp pump, heated blower, chromatherapy	2-15 amp
Air Massage Elite with Ultra Whirlpool	2 2-bhp pumps, inline heater, heated blower, chromatherapy	2-20 amp

For electrical requirements of tub options, see specific options specs
CSA Certified C/US; ANSI Z124.1 for plastic tubs and ANSI 112.19.7 for whirlpool components.

IMPORTANT ORDERING & INSTALLATION INFORMATION:

- Before ordering or installing, please consider future access to equipment.
- Add bedding compound to fully level and support bottom of tub.
- Tubs equipped with an air bath or a pre-leveled foam base are designed to rest on the floor *without* bedding compound, provided the floor is level.
- **Overall tub height is increased by approx. 2-3" when tub is equipped with any air bath package or when pre-leveled foam base or frame system is ordered.**
- Please measure tub **on-site** before building tub decking.
- If you are planning to use a glass enclosure, MTI must be advised when ordering for possible relocation of controls.
- Suction and control locations may vary.
- Specifications and configurations are subject to change without notice.
- Measurements are $\pm 1/2"$ and are subject to change without notice.
- Measurements herein supersede all others published prior to publication date shown below.













See the "Designer Collection Tubs Installation & Operation Manual" included with tub delivery or go to mtibaths.com/support/installation_operation/manuals for all the information necessary to install and operate the tub.

MTI's Customer Service Department is available Monday-Friday 8am-6pm EST at 800-783-8827 or customerservice@mtibaths.com to answer any questions pertaining to ordering or installation.



Packages and Pricing

For more information on any of the following packages, please visit: mtibaths.com/about-mti/therapies-for-wellness/

Hydrotherapy Packages	Package Contents	Part #	MSRP
 Soaker	Soaking bath - no jets	S190-DI	\$2,120
		S190-UM	
 Stream Bath	6 side vents, 2 end vents, 1-bhp pump	SM190-DI	\$3,915
		SM190-UM	
 Air Massage	20 air jets, heated air blower, pre-leveled foam base (increases overall height 2-3")	AST190-DI	\$4,820
		AST190-UM	
 Air Massage Elite	30 air jets, heated air blower, Chromatherapy LED lighting, Spa Mode, pre-leveled foam base (increases overall height 2-3")	AE190-DI	\$6,480
		AE190-UM	
 Stream Bath with Air Massage	6 side vents, 2 end vents, 1-bhp pump, 20 air jets, heated air blower, pre-leveled foam base (increases overall height 2-3")	ASTSM190-DI	\$6,615
		ASTSM190-UM	
 Stream Bath with Air Massage Elite	6 side vents, 2 end vents, 1-bhp pump, 30 air jets, heated air blower, Chromatherapy LED lighting, Spa Mode, pre-leveled foam base (increases 2-3")	AESM190-DI	\$8,275
		AESM190-UM	
 Standard Whirlpool	6 point-massage jets, 2-bhp pump	P190-DI	\$4,035
		P190-UM	
 Ultra Whirlpool	6 point-massage jets, 12 micro-jets with tsubo massage, 2 2-bhp pumps, inline heater, Ozone	P190U-DI	\$6,820
		P190U-UM	
 Air Massage with Standard Whirlpool	6 point-massage jets, 2-bhp pump, 20 air jets, heated air blower, pre-leveled foam base (increases overall height 2-3")	AW190-DI	\$6,715
		AW190-UM	
 Air Massage with Ultra Whirlpool	6 point-massage jets, 12 micro-jets with tsubo massage, 2 2-bhp pumps, inline heater, 20 air jets, heated air blower, Ozone, pre-leveled foam base (increases overall height 2-3")	AU190-DI	\$9,700
		AU190-UM	
 Air Massage Elite with Standard Whirlpool	6 point-massage jets, 2-bhp pump, 30 air jets, heated air blower, Chromatherapy LED lighting, Spa Mode, pre-leveled foam base (increases overall height 2-3")	AEAP190-DI	\$8,575
		AEAP190-UM	
 Air Massage Elite with Ultra Whirlpool	6 point-massage jets, 12 micro-jets with tsubo massage, 2 2-bhp pumps, inline heater, 30 air jets, heated air blower, Ozone, Chromatherapy LED lighting, Spa Mode, pre-leveled foam base (increases overall height 2-3")	AEAP190U-DI	\$11,060
		AEAP190U-UM	

Lead Time - Soakers, Stream Bath and Whirlpool Packages - 5 business days
Air Baths and Combo Packages - 7 business days

NOTES: • Aromatherapy is eliminated for undermount applications
• Air Baths, Pre-Leveled Foam Base or Frame Systems increase overall height by 2-3".

RECOMMENDED SENSORY THERAPIES

SEE NEXT PAGE FOR AN OVERVIEW OF AVAILABLE OPTIONS.



Chromatherapy
Underwater lighting is provided by digitally controlled LEDs. Different colors are thought to have different therapeutic effects.

LE - \$590



Audiotherapy
Stereo H2O lets you "feel" the music through the bath water. Available with Bluetooth system or transducers with leads to connect to an external system.

STEREOH2O2 - \$1,100
STEREOBT - \$1,200



Thermotherapy
Radiance uses integrated radiant heat to warm the backrest for neck, shoulders and back. Inline heaters maintain bath water temperature.

RAD100 - \$1,050
HTISOAK - \$730



Microbubbles
For wellness and beauty, billions of the tiniest air bubbles saturate the water with dissolved oxygen to moisturize and soften the skin. Available for soakers and air baths.

MICRO - \$1,995



Options and Pricing

For more information on any of the following options, please visit: mtibaths.com/about-products/tub-options/

Premium Options

NOTE: part codes for all options listed in parenthesis.

Microbubbles - Available on Soakers and Air Baths only
(MICRO) **\$1,995**

Radiance - integrated tub shell heating system
(RAD100) **\$1,050**

Chromatherapy - Included in some hydrotherapy packages
underwater LED lighting (LE) **\$590**

Stereo H₂O - Standard System - includes 4 integrated audio transducers with leads to connect to an external audio source
(STEREOH202) **\$1,100**
Bluetooth System - integrated Bluetooth system allows you to directly connect to an applicable device
(STEREOBT) **\$1,200**

Standard Options

Standard Colors: White (CWH), Bone (CBN), Biscuit (CBS)
Color Upgrade: (COL2) **\$450**, please call for availability of special colors

Quick Ship - reduces lead time - please call for availability
(QSPRI) **\$370**

Textured, Slip-Resistant Bottom - meets ASTM F-462-1994
(TXBTM) **\$75**

Virtual Spout - high-flow integrated tub filler
(FPMJ) **\$300**

Inline Heater - included in some hydrotherapy packages
For whirlpools or Stream Bath (HTI) **\$530**
Uses existing pump
Soaker or Air Baths (HTISOAK) **\$730**
Includes a recirculating pump.

Installation Aids

Pre-Levelled Foam Base - for soaker or whirlpools (PLFOAM) **\$170**

Accessories & Hardware for All Packages

Drain Kits - other finishes also available

Toe-Tap with Slim-Line Integrated Overflow

Choose from: Chrome (SLOT C), Brushed Nickel (SLOTBN),
Polished Nickel (SLOT PN) or White (SLOTWH) **\$380**

Toe-Tap with Rectangular Overflow -

Chrome (WOTRC) **\$275**
Brushed Nickel (WOTRBN) **\$280**
White (WOTRW) **\$280**

Toe-Tap with Round Overflow -

Chrome (WOTTC) **\$275**
Brushed Nickel (WOTTBN) **\$280**
Polished Nickel (WOTTPN) **\$330**

Cable Driven -

Chrome (WOCD) **\$305**
Brushed Nickel (WOCD BN) **\$375**
Polished Nickel (WOCD PN) **\$500**
Oil-Rubbed Bronze (WOCDOR) **\$500**

Lift & Turn - Chrome (WOC) **\$120**

Brushed Nickel (WOBN) **\$220**

Grab Bars - 9" Curved, set of 2

Acrylic - color-matched with tub
standard colors only (GB) **\$290**
Metal - Chrome (GBMCC), Brushed Nickel (GBMCBN) **\$320**

Pillows - from **\$120** see pillows spec at:

mtibaths.com/wp-content/uploads/2016/11/options_pillows.pdf

Teak Tub Tray - Slatted (TK-TRAY1) or Solid (TK-TRAY2) **\$395**

Teak Bath Mat (TK-MAT3018) **\$410** custom sizes also available

Accessories & Cleaning Systems for Whirlpool Packages

Trim Kits - must be ordered at time of purchase; other finishes available
Standard Whirlpool - Chrome (TRC) **\$230**; Brushed Nickel (TRBN) **\$580**
Ultra Whirlpool - Chrome (TRCU) **\$310**; Brushed Nickel (TRBNU) **\$790**

Pump Upgrade - 3-bhp (PUMP3) **\$240**

Additional Jet Options see jet options spec at mtibaths.com

Whirlpool Cleaning Systems -

Fill-Flush (FFSO) **\$575**; Simple Touch (FFE) **\$690**

Ozonator - bath water purification system (OZONE) **\$520**

