



Designer Collection Tubs
Model # 212

Andrea® 25

48" x 32" x 18"

GENERAL SPECIFICATIONS:

Material - Acrylic

Installation - Drop-in or Undermount

Soaker Weight - 90 lbs / 41 kg

Maximum Fill - 49 gal to overflow

NOTE: Filling this tub to the maximum may require an above average size or dedicated water heater.

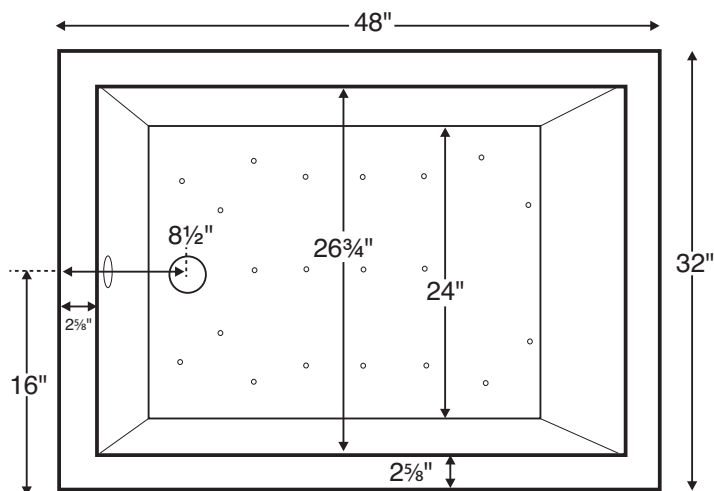

Shown with Air Massage Package.

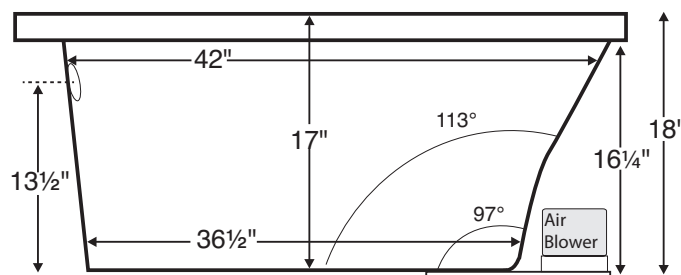

IMPORTANT:
Air baths and tubs with a pre-leveled foam base or frame system add 2-3" to overall tub height.

ELECTRICAL COMPONENTS & SPECIFICATIONS

Required Electrical Service - 110 Volt

Hydrotherapy Package	Components Included	GFCI
Air Massage	heated blower	1-15 amp
Air Massage Elite	heated blower, chromatherapy	1-15 amp

For electrical requirements of tub options, see specific options specs
CSA Certified C/US; ANSI Z124.1 for plastic tubs and ANSI 112.19.7 for whirlpool components.

IMPORTANT ORDERING & INSTALLATION INFORMATION:

- Before ordering or installing, please consider future access to equipment.
- Add bedding compound to fully level and support bottom of tub.
- Tubs equipped with an air bath or a pre-leveled foam base are designed to rest on the floor *without* bedding compound, provided the floor is level.
- **Overall tub height is increased by approx. 2-3" when tub is equipped with any air bath package or when pre-leveled foam base or frame system is ordered.**
- Please measure tub **on-site** before building tub decking.
- If you are planning to use a glass enclosure, MTI must be advised when ordering for possible relocation of controls.
- Suction and control locations may vary.
- Specifications and configurations are subject to change without notice.
- Measurements are $\pm 1/2"$ and are subject to change without notice.
- Measurements herein supersede all others published prior to publication date shown below.







See the "Designer Collection Tubs Installation & Operation Manual" included with tub delivery or go to mtibaths.com/support/installation_operation/manuals for all the information necessary to install and operate the tub.

MTI's Customer Service Department is available Monday-Friday 8am-6pm EST at 800-783-8827 or customerservice@mtibaths.com to answer any questions pertaining to ordering or installation.



Packages and Pricing

For more information on any of the following packages, please visit: mtibaths.com/about-mti/therapies-for-wellness/

Hydrotherapy Packages	Package Contents	Part #	MSRP
 Soaker	Soaking bath - no jets	S212-DI	\$1,895
		S212-UM	
 Stream Bath	6 side vents, 2 end vents, 1-bhp pump	SM212-DI	\$3,690
		SM212-UM	
 Air Massage	20 air jets, heated air blower, Aromatherapy, pre-leveled foam base (increases overall height 2-3")	AST212-DI	\$4,595
		AST212-UM	
 Air Massage Elite	30 air jets, heated air blower, Aromatherapy, Chromatherapy LED lighting, Spa Mode, pre-leveled foam base (increases overall height 2-3")	AE212-DI	\$6,255
		AE212-UM	
 Stream Bath with Air Massage	6 side vents, 2 end vents, 1-bhp pump, 20 air jets, heated air blower, Aromatherapy, pre-leveled foam base (increases overall height 2-3")	ASTSM212-DI	\$6,390
		ASTSM212-UM	
 Stream Bath with Air Massage Elite	6 side vents, 2 end vents, 1-bhp pump, 30 air jets, heated air blower, Aromatherapy, Chromatherapy LED lighting, Spa Mode, pre-leveled foam base (increases overall height 2-3")	AESM212-DI	\$8,050
		AESM212-UM	

Lead Time - Soakers, Stream Bath and Whirlpool Packages - 5 business days
Air Baths and Combo Packages - 7 business days

NOTES: • Aromatherapy is eliminated for undermount applications
• Air Baths, Pre-Leveled Foam Base or Frame Systems increase overall height by 2-3".

RECOMMENDED SENSORY THERAPIES

SEE NEXT PAGE FOR AN OVERVIEW OF AVAILABLE OPTIONS.



Chromatherapy
Underwater lighting is provided by digitally controlled LEDs. Different colors are thought to have different therapeutic effects.

LE - \$590



Audiotherapy
Stereo H₂O lets you "feel" the music through the bath water. Available with Bluetooth system or transducers with leads to connect to an external system.

STEREOH202 - \$1,100
STEREOBT - \$1,200



Thermotherapy
Radiance uses integrated radiant heat to warm the backrest for neck, shoulders and back. Inline heaters maintain bath water temperature.

RAD100 - \$1,050
HTISOAK - \$730



Microbubbles
For wellness and beauty, billions of the tiniest air bubbles saturate the water with dissolved oxygen to moisturize and soften the skin. Available for soakers and air baths.

MICRO - \$1,995



Options and Pricing

For more information on any of the following options, please visit: mtibaths.com/about-products/tub-options/

Premium Options

NOTE: part codes for all options listed in parenthesis.

Microbubbles - Available on Soakers and Air Baths only (MICRO) \$1,995
Radiance - integrated tub shell heating system (RAD100) \$1,050
Chromatherapy - Included in some hydrotherapy packages underwater LED lighting (LE) \$590
Stereo H₂O - Standard System - includes 4 integrated audio transducers with leads to connect to an external audio source (STEREOH202) \$1,100 Bluetooth System - integrated Bluetooth system allows you to directly connect to an applicable device (STEREOBT) \$1,200

Standard Options

Standard Colors: White (CWH), Bone (CBN), Biscuit (CBS) Color Upgrade: (COL2) \$450 , please call for availability of special colors
Quick Ship - reduces lead time - please call for availability (QSPRI) \$370
Textured, Slip-Resistant Bottom - meets ASTM F-462-1994 (TXBTM) \$75
Virtual Spout - high-flow integrated tub filler (FPMJ) \$300
Low-Profile Rim - reduces rim height to 1" (LPR) \$120
Inline Heater - included in some hydrotherapy packages For whirlpools or Stream Bath (HTI) \$530 Uses existing pump Soaker or Air Baths (HTISOAK) \$730 Includes a recirculating pump.

Installation Aids

Tile Flange must specify flange location(s) on order Note: Tile flange not available with Low-Profile Rim option. Factory-Installed on 3 sides - rigid ABS (TFK3) \$185 Field Install Kit - includes rigid ABS & adhesive (TFKNI) \$170
Pre-Levelled Foam Base - for soaker or whirlpools (PLFOAM) \$170
Pre-Levelled Frame and Foam Base (PLF) \$510
Pre-Levelled Frame and Foam Base with Skirting for skirting options and pricing, see spec at: mtibaths.com/wp-content/uploads/2016/01/options-skirt-acrylic.pdf

Accessories & Hardware for All Packages

Drain Kits - other finishes also available
Toe-Tap with Slim-Line Integrated Overflow Choose from: Chrome (SLOT C), Brushed Nickel (SLOTBN), Polished Nickel (SLOT PN) or White (SLOTWH) \$380
Toe-Tap with Rectangular Overflow - Chrome (WOTRC) \$275 Brushed Nickel (WOTRBN) \$280 White (WOTRW) \$280
Toe-Tap with Round Overflow - Chrome (WOTTC) \$275 Brushed Nickel (WOTTBN) \$280 Polished Nickel (WOTTPN) \$330
Cable Driven - Chrome (WOCD) \$305 Brushed Nickel (WOCDBN) \$375 Polished Nickel (WOCDPN) \$500 Oil-Rubbed Bronze (WOCBOR) \$500
Lift & Turn -Chrome (WOC) \$120 Brushed Nickel (WOBN) \$220
Grab Bars - 9" Curved, set of 2 Acrylic - color-matched with tub standard colors only (GB) \$290 Metal - Chrome (GBMCC), Brushed Nickel (GBMCBN) \$320
Pillows - from \$120 see pillows spec at: mtibaths.com/wp-content/uploads/2016/11/options_pillows.pdf
Teak Tub Tray - Slatted (TK-TRAY1) or Solid (TK-TRAY2) \$395
Teak Bath Mat (TK-MAT3018) \$410 custom sizes also available

