



Siesta 1 features integral seats.

Siesta

79.5" x 48" x 22.5"

GENERAL SPECIFICATIONS:

Material - Acrylic

Installation - Drop-in (cannot be undermounted)
Not recommended as a tub / shower combination.

Plumbed Weight - 185 lbs / 84 kg

Soaker Weight - 120 lbs / 55 kg

Average Fill - 54 gal to above jet level

Maximum Fill - 107 gal to overflow

NOTE: Filling this tub to the maximum may require an above average size or dedicated water heater.

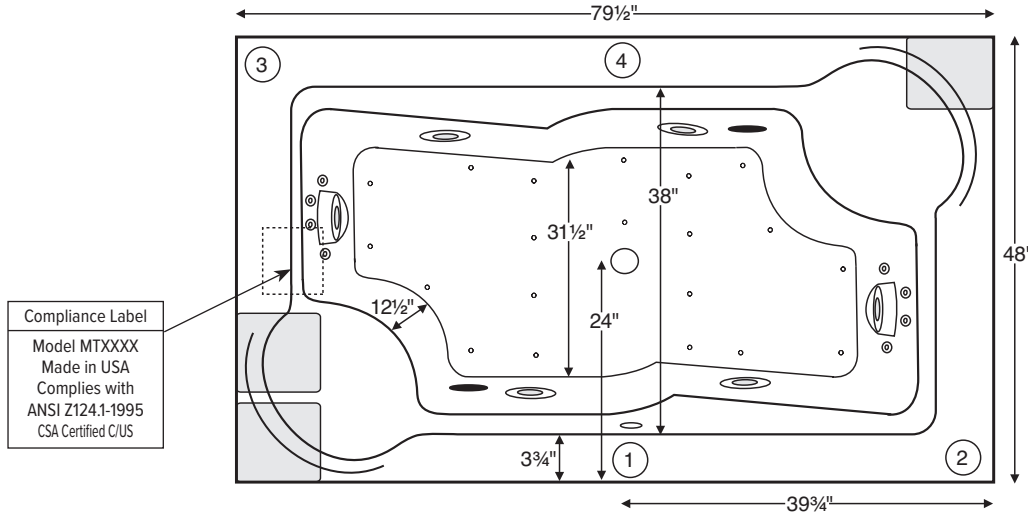

Compliance Label
Model MTXXXX
Made in USA
Complies with
ANSI Z124.1-1995
CSA Certified C/US

Numbered areas on tub deck represent possible locations to install cleaning systems, faucets and other fixtures.

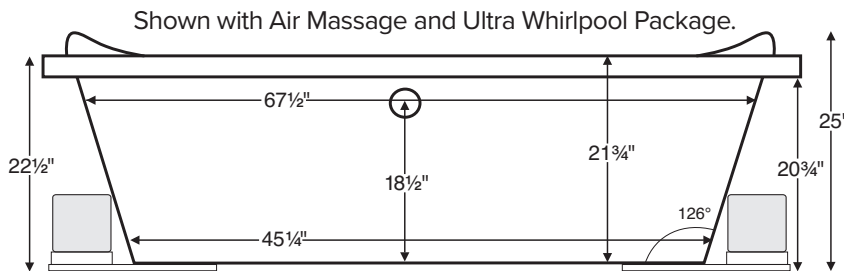

IMPORTANT:
Air baths and tubs with a pre-leveled foam base or frame system add 2-3" to overall tub height.

ELECTRICAL COMPONENTS & SPECIFICATIONS		
Required Electrical Service - 110 Volt		
Hydrotherapy Package	Components Included	GFCI
Standard Whirlpool	2-bhp pump, inline heater	2-15 amp
Ultra Whirlpool	2 2-bhp pumps, inline heater	2-20 amp
Air Massage	heated blower	1-15 amp
Air Massage Elite	heated blower, chromatherapy	1-15 amp
Air Massage with Standard Whirlpool	2-bhp pump, inline heater, heated blower	1-15 amp 2-20 amp
Air Massage with Ultra Whirlpool	2 2-bhp pumps, inline heater, heated blower	2-20 amp
Air Massage Elite with Standard Whirlpool	2-bhp pump, inline heater, heated blower, chromatherapy	1-15 amp 1-20amp
Air Massage Elite with Ultra Whirlpool	2 2-bhp pumps, inline heater, heated blower, chromatherapy	2-20 amp

For electrical requirements of tub options, see specific options specs
CSA Certified C/US; ANSI Z124.1 for plastic tubs and ANSI 112.19.7 for whirlpool components.

IMPORTANT ORDERING & INSTALLATION INFORMATION:

- Before ordering or installing, please consider future access to equipment.
- Add bedding compound to fully level and support bottom of tub.
- Tubs equipped with an air bath or a pre-leveled foam base are designed to rest on the floor *without* bedding compound, provided the floor is level.
- **Overall tub height is increased by approx. 2-3" when tub is equipped with any air bath package or when pre-leveled foam base or frame system is ordered.**
- Please measure tub **on-site** before building tub decking.
- If you are planning to use a glass enclosure, MTI must be advised when ordering for possible relocation of controls.
- Suction and control locations may vary.
- Specifications and configurations are subject to change without notice.
- Measurements are $\pm 1/2"$ and are subject to change without notice.
- Measurements herein supersede all others published prior to publication date shown below.









See the "Designer Collection Tubs Installation & Operation Manual" included with tub delivery or go to mtibaths.com/support/installation_operation/manuals for all the information necessary to install and operate the tub.

MTI's Customer Service Department is available Monday-Friday 8am-6pm EST at 800-783-8827 or customerservice@mtibaths.com to answer any questions pertaining to ordering or installation.



Packages and Pricing

For more information on any of the following packages, please visit: mtibaths.com/about-mti/therapies-for-wellness/

Hydrotherapy Packages	Package Contents	Part #	MSRP
 Soaker	Soaking bath - no jets, includes a textured bottom	S33	\$2,645
 Air Massage	20 air jets, heated air blower, Aromatherapy, textured bottom, pre-leveled foam base (increases overall height 2-3")	AST33	\$5,345
 Air Massage Elite	30 air jets, heated air blower, Aromatherapy, Chromatherapy LED lighting, Spa Mode, textured bottom, pre-leveled foam base (increases overall height 2-3")	AE33	\$7,005
 Standard Whirlpool	6 point-massage jets, 2-bhp pump, inline heater, textured bottom	P33	\$5,110
 Ultra Whirlpool	6 point-massage jets, 8 micro-jets with Tsubo massage, 2 2-bhp pumps, inline heater, Ozone, textured bottom	P33U	\$6,950
 Air Massage with Standard Whirlpool	6 point-massage jets, 2-bhp pump, inline heater, 20 air jets, heated air blower, Aromatherapy, textured bottom, pre-leveled foam base (increases overall height 2-3")	AW33	\$7,430
 Air Massage with Ultra Whirlpool	6 point-massage jets, 8 micro jets with Tsubo massage, 2 2-bhp pumps, inline heater, 20 air jets, heated air blower, Aromatherapy, Ozone, textured bottom, pre-leveled foam base (increases overall height 2-3")	AU33	\$9,225
 Air Massage Elite with Standard Whirlpool	6 point-massage jets, 2-bhp pump, inline heater, 30 air jets, heated air blower, Aromatherapy, Chromatherapy LED lighting, Spa Mode, textured bottom, pre-leveled foam base (increases overall height 2-3")	AEAP33	\$9,460
 Air Massage Elite with Ultra Whirlpool	6 point-massage jets, 8 micro-jets with Tsubo massage, 2 2-bhp pumps, inline heater, 30 air jets, heated air blower, Aromatherapy, Ozone, Chromatherapy LED lighting, Spa Mode, textured bottom, pre-leveled foam base (increases overall height 2-3")	AEAP33U	\$11,145

Lead Time - Soakers, Stream Bath and Whirlpool Packages - 5 business days
Air Baths and Combo Packages - 7 business days

NOTES: • Aromatherapy is eliminated for undermount applications
• Air Baths, Pre-Leveled Foam Base or Frame Systems increase overall height by 2-3".

RECOMMENDED SENSORY THERAPIES

SEE NEXT PAGE FOR AN OVERVIEW OF AVAILABLE OPTIONS.



Chromatherapy
Underwater lighting is provided by digitally controlled LEDs. Different colors are thought to have different therapeutic effects.

LE - \$590



Audiotherapy
Stereo H₂O lets you "feel" the music through the bath water. Available with Bluetooth system or transducers with leads to connect to an external system.

STEREOH202 - \$1,100
STEREOBT - \$1,200



Thermotherapy
Radiance uses integrated radiant heat to warm the backrest for neck, shoulders and back. Inline heaters maintain bath water temperature.

RAD100 - \$1,050
HTISOAK - \$730



Microbubbles
For wellness and beauty, billions of the tiniest air bubbles saturate the water with dissolved oxygen to moisturize and soften the skin. Available for soakers and air baths.

MICRO - \$1,995



Options and Pricing

For more information on any of the following options, please visit: mtibaths.com/about-products/tub-options/

Premium Options

NOTE: part codes for all options listed in parenthesis.

Microbubbles - Available on Soakers and Air Baths only (MICRO) **\$1,995**

Radiance - integrated tub shell heating system (RAD100) **\$1,050**

Chromatherapy - Included in some hydrotherapy packages underwater LED lighting (LE) **\$590**

Stereo H₂O - Standard System - includes 4 integrated audio transducers with leads to connect to an external audio source (STEREOH202) **\$1,100**
Bluetooth System - integrated Bluetooth system allows you to directly connect to an applicable device (STEREOBT) **\$1,200**

Standard Options

Standard Colors: White (CWH), Bone (CBN), Biscuit (CBS)
Color Upgrade: (COL2) **\$450**, please call for availability of special colors

Quick Ship - reduces lead time - please call for availability (QSPRI) **\$370**

Virtual Spout - high-flow integrated tub filler (FPMJ) **\$300**

Inline Heater - included in some hydrotherapy packages For whirlpools or Stream Bath (HTI) **\$530**
 Uses existing pump
 Soaker or Air Baths (HTISOAK) **\$730**
 Includes a recirculating pump.

Installation Aids

Tile Flange must specify flange location(s) on order
 Note: Tile flange not available with Low-Profile Rim option.
 Factory-Installed on 3 sides - rigid ABS (TFK3) **\$185**
 Field Install Kit - includes rigid ABS & adhesive (TFKNI) **\$170**

Pre-Leveled Foam Base - for soaker or whirlpools (PLFOAM) **\$170**

Pre-Leveled Frame and Foam Base (PLF) **\$510**

Pre-Leveled Frame and Foam Base with Skirt
 Acrylic Contemporary Euro-Style with Removable Panels (FSKE65) **\$1,350**
 Acrylic Skirting Color Upgrade (COL2) **\$450**



Optional Acrylic Contemporary Euro-Style Skirt

Accessories & Hardware for All Packages

Drain Kits - other finishes also available

Toe-Tap with Slim-Line Integrated Overflow
 Choose from: Chrome (SLOT), Brushed Nickel (SLOTBN), Polished Nickel (SLOTPN) or White (SLOTWH) **\$380**

Toe-Tap with Rectangular Overflow -
 Chrome (WOTRC) **\$275**
 Brushed Nickel (WOTRBN) **\$280**
 White (WOTRW) **\$280**

Toe-Tap with Round Overflow -
 Chrome (WOTTC) **\$275**
 Brushed Nickel (WOTTBN) **\$280**
 Polished Nickel (WOTTPN) **\$330**

Cable Driven -
 Chrome (WOCD) **\$305**
 Brushed Nickel (WOCDBN) **\$375**
 Polished Nickel (WOCDPN) **\$500**
 Oil-Rubbed Bronze (WOCDOR) **\$500**

Lift & Turn -Chrome (WOC) **\$120**
 Brushed Nickel (WOBN) **\$220**

Grab Bars - 9" Curved, set of 2
 Acrylic - color-matched with tub standard colors only (GB) **\$290**
 Metal - Chrome (GBMCC), Brushed Nickel (GBMCBN) **\$320**

Pillows - from **\$120** see pillows spec at: mtibaths.com/wp-content/uploads/2016/11/options_pillows.pdf

Teak Tub Tray - Slatted (TK-TRAY1) or Solid (TK-TRAY2) **\$395**

Teak Bath Mat (TK-MAT3018) **\$410** custom sizes also available

Accessories & Cleaning Systems for Whirlpool Packages

Trim Kits - must be ordered at time of purchase; other finishes available
 Standard Whirlpool - Chrome (TRC) **\$230**; Brushed Nickel (TRBN) **\$580**
 Ultra Whirlpool - Chrome (TRCU) **\$310**; Brushed Nickel (TRBNU) **\$790**

Pump Upgrade - 3-bhp (PUMP3) **\$240**

Additional Jet Options see jet options spec at mtibaths.com

Whirlpool Cleaning Systems -
 Fill-Flush (FFSO) **\$575**; Simple Touch (FFE) **\$690**

Ozonator - bath water purification system (OZONE) **\$520**

