

# Cayman 4

59.875" x 59.875" x 24.25"



**GENERAL SPECIFICATIONS:**

- Material** - Acrylic
  - Installation** - Drop-in (cannot be undermounted)  
*Not recommended as a tub / shower combination.*
  - Plumbed Weight** - 185 lbs / 84 kg
  - Soaker Weight** - 120 lbs / 55 kg
  - Average Fill** - 56 gal to above jet level
  - Maximum Fill** - 86 gal to overflow
- NOTE: Filling this tub to the maximum may require an above average size or dedicated water heater.*

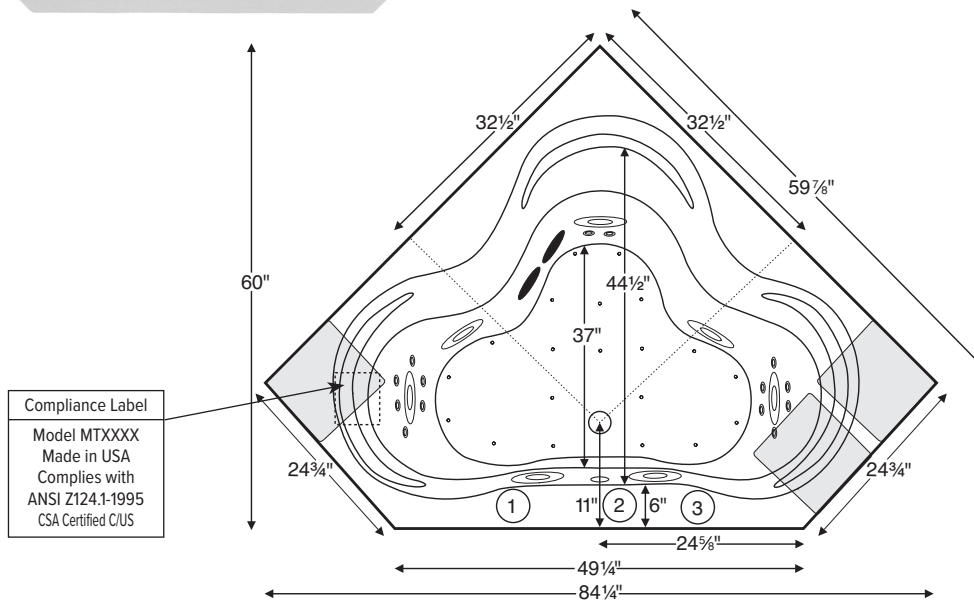

Numbered areas on tub deck represent possible locations to install cleaning systems, faucets and other fixtures.  
Shown with Air Massage and Ultra Whirlpool Package.

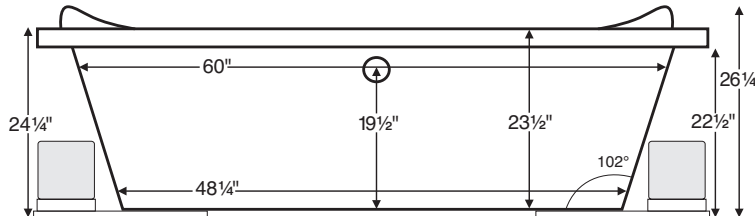

**IMPORTANT:**  
Air baths and tubs with a pre-leveled foam base or frame system add 2-3" to overall tub height.

ELECTRICAL COMPONENTS & SPECIFICATIONS		
Required Electrical Service - 110 Volt		
Hydrotherapy Package	Components Included	GFCI
Standard Whirlpool	2-bhp pump	1-15 amp
Ultra Whirlpool	2 2-bhp pumps, inline heater	2-20 amp
Air Massage	heated blower	1-15 amp
Air Massage Elite	heated blower, chromatherapy	1-15 amp
Air Massage with Standard Whirlpool	2-bhp pump, heated blower	2-15 amp
Air Massage with Ultra Whirlpool	2 2-bhp pumps, inline heater, heated blower	2-20 amp
Air Massage Elite with Standard Whirlpool	2-bhp pump, heated blower, chromatherapy	2-15 amp
Air Massage Elite with Ultra Whirlpool	2 2-bhp pumps, inline heater, heated blower, chromatherapy	2-20 amp

*For electrical requirements of tub options, see specific options specs*  
CSA Certified C/US; ANSI Z124.1 for plastic tubs and ANSI 112.19.7 for whirlpool components.

**IMPORTANT ORDERING & INSTALLATION INFORMATION:**









- Before ordering or installing, please consider future access to equipment.
- Add bedding compound to fully level and support bottom of tub.
- Tubs equipped with an air bath or a pre-leveled foam base are designed to rest on the floor *without* bedding compound, provided the floor is level.
- **Overall tub height is increased by approx. 2-3" when tub is equipped with any air bath package or when pre-leveled foam base or frame system is ordered.**
- Please measure tub **on-site** before building tub decking.
- If you are planning to use a glass enclosure, MTI must be advised when ordering for possible relocation of controls.
- Suction and control locations may vary.
- Specifications and configurations are subject to change without notice.
- Measurements are ±1/2" and are subject to change without notice.
- Measurements herein supersede all others published prior to publication date shown below.

See the "Designer Collection Tubs Installation & Operation Manual" included with tub delivery or go to [mtibaths.com/support/installation\\_operation/manuals](http://mtibaths.com/support/installation_operation/manuals) for all the information necessary to install and operate the tub.  
MTI's Customer Service Department is available Monday-Friday 8am-6pm EST at 800-783-8827 or [customerservice@mtibaths.com](mailto:customerservice@mtibaths.com) to answer any questions pertaining to ordering or installation.



### Packages and Pricing

For more information on any of the following packages, please visit: [mtibaths.com/about-mti/therapies-for-wellness/](http://mtibaths.com/about-mti/therapies-for-wellness/)

Hydrotherapy Packages	Package Contents	Part #	MSRP
 Soaker	Soaking bath - no jets	S36	\$2,490
 Air Massage	20 air jets, heated air blower, Aromatherapy, pre-leveled foam base (increases overall height 2-3")	AST36	\$5,190
 Air Massage Elite	30 air jets, heated air blower, Aromatherapy, Chromatherapy LED lighting, Spa Mode, pre-leveled foam base (increases overall height 2-3")	AE36	\$6,850
 Standard Whirlpool	7 point-massage jets, 2-bhp pump	P36	\$4,455
 Ultra Whirlpool	7 point-massage jets, 14 micro-jets with Tsubo massage, 2 2-bhp pumps, inline heater, Ozone	P36U	\$7,535
 Air Massage with Standard Whirlpool	7 point-massage jets, 2-bhp pump, 20 air jets, heated air blower, Aromatherapy, pre-leveled foam base (increases overall height 2-3")	AW36	\$7,285
 Air Massage with Ultra Whirlpool	7 point-massage jets, 14 micro jets with Tsubo massage, 2 2-bhp pumps, inline heater, 20 air jets, heated air blower, Aromatherapy, Ozone, pre-leveled foam base (increases overall height 2-3")	AU36	\$9,875
 Air Massage Elite with Standard Whirlpool	7 point-massage jets, 2-bhp pump, 30 air jets, heated air blower, Aromatherapy, Chromatherapy LED lighting, Spa Mode, pre-leveled foam base (increases overall height 2-3")	AEAP36	\$8,270
 Air Massage Elite with Ultra Whirlpool	7 point-massage jets, 14 micro-jets with Tsubo massage, 2 2-bhp pumps, inline heater, 30 air jets, heated air blower, Aromatherapy, Ozone, Chromatherapy LED lighting, Spa Mode, pre-leveled foam base (increases overall height 2-3")	AEAP36U	\$11,215

**Lead Time** - Soakers, Stream Bath and Whirlpool Packages - 5 business days  
Air Baths and Combo Packages - 7 business days

**NOTES:** • Aromatherapy is eliminated for undermount applications  
• Air Baths, Pre-Leveled Foam Base or Frame Systems increase overall height by 2-3".

#### RECOMMENDED SENSORY THERAPIES

SEE NEXT PAGE FOR AN OVERVIEW OF AVAILABLE OPTIONS.



**Chromatherapy**  
Underwater lighting is provided by digitally controlled LEDs. Different colors are thought to have different therapeutic effects.

LE - \$590



**Audiotherapy**  
Stereo H<sub>2</sub>O lets you "feel" the music through the bath water. Available with Bluetooth system or transducers with leads to connect to an external system.

STEREOH2O2 - \$1,100  
STEREOBT - \$1,200



**Thermotherapy**  
Radiance uses integrated radiant heat to warm the backrest for neck, shoulders and back. Inline heaters maintain bath water temperature.

RAD100 - \$1,050  
HTISOAK - \$730



**Microbubbles**  
For wellness and beauty, billions of the tiniest air bubbles saturate the water with dissolved oxygen to moisturize and soften the skin. Available for soakers and air baths.

MICRO - \$1,995



### Options and Pricing

For more information on any of the following options, please visit: [mtibaths.com/about-products/tub-options/](http://mtibaths.com/about-products/tub-options/)

<b>Premium Options</b> NOTE: part codes for all options listed in parenthesis.
<b>Microbubbles</b> - Available on Soakers and Air Baths only (MICRO) <b>\$1,995</b>
<b>Radiance</b> - integrated tub shell heating system (RAD100) <b>\$1,050</b>
<b>Chromatherapy</b> - Included in some hydrotherapy packages underwater LED lighting (LE) <b>\$590</b>
<b>Stereo H<sub>2</sub>O - Standard System</b> - includes 4 integrated audio transducers with leads to connect to an external audio source (STEREOH202) <b>\$1,100</b> <b>Bluetooth System</b> - integrated Bluetooth system allows you to directly connect to an applicable device (STEREOBT) <b>\$1,200</b>
<b>Standard Options</b>
<b>Standard Colors:</b> White (CWH), Bone (CBN), Biscuit (CBS) <b>Color Upgrade:</b> (COL2) <b>\$450</b> , please call for availability of special colors
<b>Quick Ship</b> - reduces lead time - please call for availability (QSPRI) <b>\$370</b>
<b>Textured, Slip-Resistant Bottom</b> - meets ASTM F-462-1994 (TXBTM) <b>\$75</b>
<b>Virtual Spout</b> - high-flow integrated tub filler (FPMJ) <b>\$300</b>
<b>Inline Heater</b> - included in some hydrotherapy packages For whirlpools or Stream Bath (HTI) <b>\$530</b> Uses existing pump Soaker or Air Baths (HTISOAK) <b>\$730</b> Includes a recirculating pump.
<b>Installation Aids</b>
<b>Tile Flange</b> must specify flange location(s) on order Note: Tile flange not available with Low-Profile Rim option. Factory-Installed on 3 sides - rigid ABS (TFK3) <b>\$185</b> Field Install Kit - includes rigid ABS & adhesive (TFKNI) <b>\$170</b>
<b>Pre-Leveled Foam Base</b> - for soaker or whirlpools (PLFOAM) <b>\$170</b>
<b>Pre-Leveled Frame and Foam Base (PLF)</b> <b>\$510</b>
<b>Pre-Leveled Frame and Foam Base with Skirting</b> for skirting options and pricing, see spec at: <a href="http://mtibaths.com/wp-content/uploads/2016/01/options-skirt_acrylic.pdf">mtibaths.com/wp-content/uploads/2016/01/options-skirt_acrylic.pdf</a>

<b>Accessories &amp; Hardware for All Packages</b>
<b>Drain Kits</b> - other finishes also available
<b>Toe-Tap with Slim-Line Integrated Overflow</b> Choose from: Chrome (SLOT), Brushed Nickel (SLOTBN), Polished Nickel (SLOTPN) or White (SLOTWH) <b>\$380</b>
<b>Toe-Tap with Rectangular Overflow</b> - Chrome (WOTRC) <b>\$275</b> Brushed Nickel (WOTRBN) <b>\$280</b> White (WOTRW) <b>\$280</b>
<b>Toe-Tap with Round Overflow</b> - Chrome (WOTTC) <b>\$275</b> Brushed Nickel (WOTTBN) <b>\$280</b> Polished Nickel (WOTTPN) <b>\$330</b>
<b>Cable Driven</b> - Chrome (WOCD) <b>\$305</b> Brushed Nickel (WOCDBN) <b>\$375</b> Polished Nickel (WOCDPN) <b>\$500</b> Oil-Rubbed Bronze (WOCDOR) <b>\$500</b>
<b>Lift &amp; Turn</b> -Chrome (WOC) <b>\$120</b> Brushed Nickel (WOBN) <b>\$220</b>
<b>Grab Bars</b> - 9" Curved, set of 2 Acrylic - color-matched with tub standard colors only (GB) <b>\$290</b> Metal - Chrome (GBMCC), Brushed Nickel (GBMCBN) <b>\$320</b>
<b>Pillows</b> - from <b>\$120</b> see pillows spec at: <a href="http://mtibaths.com/wp-content/uploads/2016/11/options_pillows.pdf">mtibaths.com/wp-content/uploads/2016/11/options_pillows.pdf</a>
<b>Teak Bath Mat (TK-MAT3018)</b> <b>\$410</b> custom sizes also available
<b>Accessories &amp; Cleaning Systems for Whirlpool Packages</b>
<b>Trim Kits</b> - must be ordered at time of purchase; other finishes available Standard Whirlpool - Chrome (TRC) <b>\$230</b> ; Brushed Nickel (TRBN) <b>\$580</b> Ultra Whirlpool - Chrome (TRCU) <b>\$310</b> ; Brushed Nickel (TRBNU) <b>\$790</b>
<b>Pump Upgrade</b> - 3-bhp (PUMP3) <b>\$240</b>
<b>Additional Jet Options</b> see jet options spec at <a href="http://mtibaths.com">mtibaths.com</a>
<b>Whirlpool Cleaning Systems</b> - Fill-Flush (FFSO) <b>\$575</b> ; Simple Touch (FFE) <b>\$690</b>
<b>Ozonator</b> - bath water purification system (OZONE) <b>\$520</b>

