

Cayman 7

72" x 72" x 23.25"

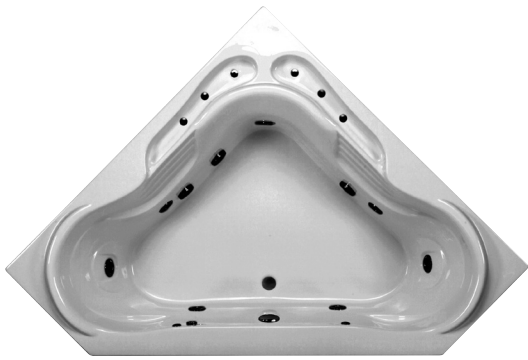

Shown with Standard Whirlpool package and optional Trim Kit.

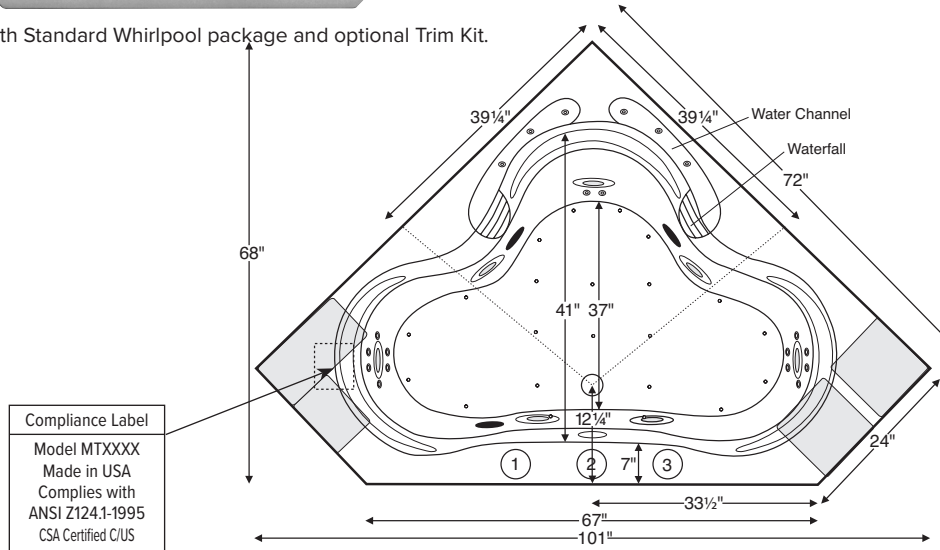

Compliance Label
Model MTXXXX
Made in USA
Complies with
ANSI Z124.1-1995
CSA Certified C/US

Numbered areas on tub deck represent possible locations to install cleaning systems, faucets and other fixtures.

Shown with Air Massage and Ultra Whirlpool Package.

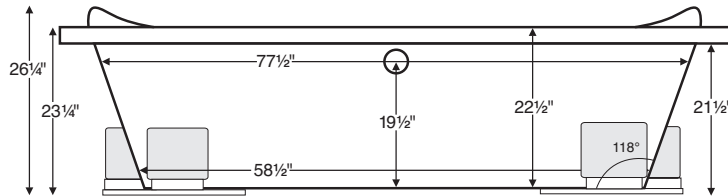

IMPORTANT:
Air baths and tubs with a pre-leveled foam base or frame system add 2-3" to overall tub height.

ELECTRICAL COMPONENTS & SPECIFICATIONS		
Required Electrical Service - 110 Volt		
Hydrotherapy Package	Components Included	GFCI
Soaker	recirculating waterfall pump	1-15 amp
Standard Whirlpool	2-bhp pump, recirculating waterfall pump	1-15 amp, 1-20 amp
Ultra Whirlpool	2 2-bhp pumps, inline heater, recirculating waterfall pump	2-20 amp
Air Massage	heated blower, recirculating waterfall pump	1-15 amp, 1-20 amp
Air Massage Elite	heated blower, chromatherapy, recirculating waterfall pump	1-15 amp, 1-20 amp
Air Massage with Standard Whirlpool	2-bhp pump, heated blower, recirculating waterfall pump	2-20 amp
Air Massage with Ultra Whirlpool	2 2-bhp pumps, inline heater, heated blower, recirculating waterfall pump	2-20 amp
Air Massage Elite with Standard Whirlpool	2-bhp pump, heated blower, chromatherapy, recirculating waterfall pump	2-20 amp
Air Massage Elite with Ultra Whirlpool	2 2-bhp pumps, inline heater, heated blower, chromatherapy, recirculating waterfall pump	2-20 amp

For electrical requirements of tub options, see specific options specs
CSA Certified C/US; ANSI Z124.1 for plastic tubs and ANSI 112.19.7 for whirlpool components.

IMPORTANT ORDERING & INSTALLATION INFORMATION:

- Before ordering or installing, please consider future access to equipment.
- Add bedding compound to fully level and support bottom of tub.
- Tubs equipped with an air bath or a pre-leveled foam base are designed to rest on the floor without bedding compound, provided the floor is level.
- **Overall tub height is increased by approx. 2-3" when tub is equipped with any air bath package or when pre-leveled foam base or frame system is ordered.**
- Please measure tub **on-site** before building tub decking.
- If you are planning to use a glass enclosure, MTI must be advised when ordering for possible relocation of controls.
- Suction and control locations may vary.
- Specifications and configurations are subject to change without notice.
- Measurements are $\pm 1/2"$ and are subject to change without notice.
- Measurements herein supersede all others published prior to publication date shown below.









See the "Designer Collection Tubs Installation & Operation Manual" included with tub delivery or go to mtibaths.com/support/installation_operation/manuals for all the information necessary to install and operate the tub.

MTI's Customer Service Department is available Monday-Friday 8am-6pm EST at 800-783-8827 or customerservice@mtibaths.com to answer any questions pertaining to ordering or installation.



Packages and Pricing

For more information on any of the following packages, please visit: mtibaths.com/about-mti/therapies-for-wellness/

Hydrotherapy Packages	Package Contents	Part #	MSRP
 Soaker	Soaking bath - no jets; 2 cascading waterfalls with recirculating pump	S60	\$4,155
 Air Massage	20 air jets, heated air blower, Aromatherapy, pre-leveled foam base (increases overall height 2-3"); 2 cascading waterfalls with recirculating pump	AST60	\$6,855
 Air Massage Elite	30 air jets, heated air blower, Aromatherapy, Chromatherapy LED lighting, Spa Mode, pre-leveled foam base (increases overall height 2-3"); 2 cascading waterfalls with recirculating pump	AE60	\$8,515
 Standard Whirlpool	7 point-massage jets, 2-bhp pump, inline heater; 2 cascading waterfalls with recirculating pump	P60	\$6,240
 Ultra Whirlpool	7 point-massage jets, 14 micro-jets with Tsubo massage, 2 2-bhp pumps, inline heater, Ozone; 2 cascading waterfalls with recirculating pump	P60U	\$9,260
 Air Massage with Standard Whirlpool	7 point-massage jets, 2-bhp pump, inline heater, 20 air jets, heated air blower, Aromatherapy, pre-leveled foam base (increases overall height 2-3"); 2 cascading waterfalls with recirculating pump	AW60	\$8,835
 Air Massage with Ultra Whirlpool	7 point-massage jets, 14 micro jets with Tsubo massage, 2 2-bhp pumps, inline heater, 20 air jets, heated air blower, Aromatherapy, Ozone, pre-leveled foam base (increases overall height 2-3"); 2 cascading waterfalls with recirculating pump	AU60	\$12,155
 Air Massage Elite with Standard Whirlpool	7 point-massage jets, 2-bhp pump, inline heater, 30 air jets, heated air blower, Aromatherapy, Chromatherapy LED lighting, Spa Mode, pre-leveled foam base (increases overall height 2-3"); 2 cascading waterfalls with recirculating pump	AEAP60	\$10,935
 Air Massage Elite with Ultra Whirlpool	7 point-massage jets, 14 micro-jets with Tsubo massage, 2 2-bhp pumps, inline heater, 30 air jets, heated air blower, Aromatherapy, Ozone, Chromatherapy LED lighting, Spa Mode, pre-leveled foam base (increases overall height 2-3"); 2 cascading waterfalls with recirculating pump	AEAP60U	\$14,135

Lead Time - Soakers, Stream Bath and Whirlpool Packages - 5 business days
Air Baths and Combo Packages - 7 business days

NOTES: • Aromatherapy is eliminated for undermount applications
• Air Baths, Pre-Leveled Foam Base or Frame Systems increase overall height by 2-3".

RECOMMENDED SENSORY THERAPIES

SEE NEXT PAGE FOR AN OVERVIEW OF AVAILABLE OPTIONS.



Chromatherapy
Underwater lighting is provided by digitally controlled LEDs. Different colors are thought to have different therapeutic effects.

LE - \$590



Audiotherapy
Stereo H₂O lets you "feel" the music through the bath water. Available with Bluetooth system or transducers with leads to connect to an external system.

STEREOH2O2 - \$1,100
STEREOBT - \$1,200



Thermotherapy
Radiance uses integrated radiant heat to warm the backrest for neck, shoulders and back. Inline heaters maintain bath water temperature.

RAD100 - \$1,050
HTISOAK - \$730



Microbubbles
For wellness and beauty, billions of the tiniest air bubbles saturate the water with dissolved oxygen to moisturize and soften the skin. Available for soakers and air baths.

MICRO - \$1,995



Options and Pricing

For more information on any of the following options, please visit: mtibaths.com/about-products/tub-options/

<p>Premium Options NOTE: part codes for all options listed in parenthesis.</p> <p>Microbubbles - Available on Soakers and Air Baths only (MICRO) \$1,995</p> <p>Radiance - integrated tub shell heating system (RAD100) \$1,050</p> <p>Chromatherapy - Included in some hydrotherapy packages underwater LED lighting (LE) \$590</p> <p>Stereo H₂O - Standard System - includes 4 integrated audio transducers with leads to connect to an external audio source (STEREOH202) \$1,100 Bluetooth System - integrated Bluetooth system allows you to directly connect to an applicable device (STEREOBT) \$1,200</p>
<p>Standard Options</p> <p>Standard Colors: White (CWH), Bone (CBN), Biscuit (CBS) Color Upgrade: (COL2) \$450, please call for availability of special colors</p> <p>Quick Ship - reduces lead time - please call for availability (QSPRI) \$370</p> <p>Textured, Slip-Resistant Bottom - meets ASTM F-462-1994 (TXBTM) \$75</p> <p>Virtual Spout - high-flow integrated tub filler (FPMJ) \$300</p> <p>Inline Heater - included in some hydrotherapy packages For whirlpools or Stream Bath (HTI) \$530 Uses existing pump Soaker or Air Baths (HTISOAK) \$730 Includes a recirculating pump.</p>
<p>Installation Aids</p> <p>Tile Flange must specify flange location(s) on order Note: Tile flange not available with Low-Profile Rim option. Factory-Installed on 3 sides - rigid ABS (TFK3) \$185 Field Install Kit - includes rigid ABS & adhesive (TFKNI) \$170</p> <p>Pre-Levelled Foam Base - for soaker or whirlpools (PLFOAM) \$170</p> <p>Pre-Levelled Frame and Foam Base (PLF) \$510</p> <p>Pre-Levelled Frame and Foam Base with Skirting for skirting options and pricing, see spec at: mtibaths.com/wp-content/uploads/2016/01/options-skirt_acrylic.pdf</p>

<p>Accessories & Hardware for All Packages</p> <p>Drain Kits - other finishes also available</p> <p>Toe-Tap with Round Overflow - Chrome (WOTTC) \$275 Brushed Nickel (WOTTBN) \$280 Polished Nickel (WOTTPN) \$330</p> <p>Cable Driven - Chrome (WOCD) \$305 Brushed Nickel (WOCDBN) \$375 Polished Nickel (WOCDPN) \$500 Oil-Rubbed Bronze (WOCDOR) \$500</p> <p>Lift & Turn -Chrome (WOC) \$120 Brushed Nickel (WOBN) \$220</p> <p>Grab Bars - 9" Curved, set of 2 Acrylic - color-matched with tub standard colors only (GB) \$290 Metal - Chrome (GBMCC), Brushed Nickel (GBMCBN) \$320</p> <p>Pillows - from \$120 see pillows spec at: mtibaths.com/wp-content/uploads/2016/11/options_pillows.pdf</p> <p>Teak Bath Mat (TK-MAT3018) \$410 custom sizes also available</p>
<p>Accessories & Cleaning Systems for Whirlpool Packages</p> <p>Trim Kits - must be ordered at time of purchase; other finishes available Standard Whirlpool - Chrome (TRC) \$230; Brushed Nickel (TRBN) \$580 Ultra Whirlpool - Chrome (TRCU) \$310; Brushed Nickel (TRBNU) \$790</p> <p>Pump Upgrade - 3-bhp (PUMP3) \$240</p> <p>Additional Jet Options see jet options spec at mtibaths.com</p> <p>Whirlpool Cleaning Systems - Fill-Flush (FFSO) \$575; Simple Touch (FFE) \$690</p> <p>Ozonator - bath water purification system (OZONE) \$520</p>

