



# Atlantica

50" x 23.625" / 34.75 x 23.75"

### GENERAL SPECIFICATIONS:

**Material** - Acrylic

**Installation** - Drop-in or undermount  
*Not recommended as a tub / shower combination.*

**Plumbed Weight** - 150 lbs / 68 kg

**Soaker Weight** - 100 lbs / 45 kg

**Average Fill** - 38 gal to above jet level

**Maximum Fill** - 71 gal to overflow

*NOTE: Filling this tub to the maximum may require an above average size or dedicated water heater.*

### PLEASE NOTE:

**This tub is very small and is intended for applications where space is extremely limited.**

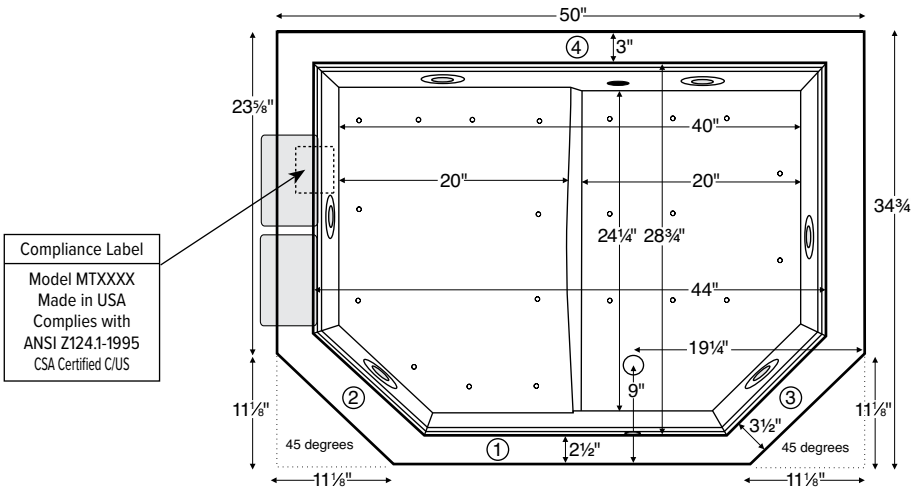

Numbered areas on tub deck represent possible locations to install cleaning systems, faucets and other fixtures.

**Pump extends 6"-7" beyond edge of tub.**

Shown with Air Massage and Standard Whirlpool Package.

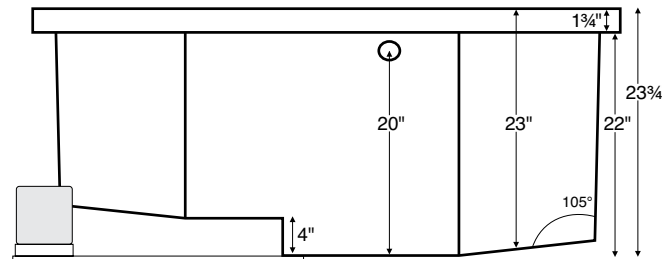

### IMPORTANT:

Air baths and tubs with a pre-leveled foam base or frame system add 2-3" to overall tub height.

ELECTRICAL COMPONENTS & SPECIFICATIONS		
Required Electrical Service - 110 Volt		
Hydrotherapy Package	Components Included	GFCI
Standard Whirlpool	2-bhp pump	1-15 amp
Air Massage	heated blower	1-15 amp
Air Massage Elite	heated blower, chromatherapy	1-15 amp
Air Massage with Standard Whirlpool	2-bhp pump, heated blower	2-15 amp
Air Massage Elite with Standard Whirlpool	2-bhp pump, heated blower, chromatherapy	2-15 amp

*For electrical requirements of tub options, see specific options specs*  
CSA Certified C/US; ANSI Z124.1 for plastic tubs and ANSI 112.19.7 for whirlpool components.

### IMPORTANT ORDERING & INSTALLATION INFORMATION:

- Before ordering or installing, please consider future access to equipment.
- Add bedding compound to fully level and support bottom of tub.
- Tubs equipped with an air bath or a pre-leveled foam base are designed to rest on the floor *without* bedding compound, provided the floor is level.
- **Overall tub height is increased by approx. 2-3" when tub is equipped with any air bath package or when pre-leveled foam base or frame system is ordered.**
- Please measure tub **on-site** before building tub decking.
- If you are planning to use a glass enclosure, MTI must be advised when ordering for possible relocation of controls.
- Suction and control locations may vary.
- Specifications and configurations are subject to change without notice.
- Measurements are  $\pm 1/2"$  and are subject to change without notice.
- Measurements herein supersede all others published prior to publication date shown below.







See the "Designer Collection Tubs Installation & Operation Manual" included with tub delivery or go to [mtibaths.com/support/installation\\_operation/manuals](http://mtibaths.com/support/installation_operation/manuals) for all the information necessary to install and operate the tub.

MTI's Customer Service Department is available Monday-Friday 8am-6pm EST at 800-783-8827 or [customerservice@mtibaths.com](mailto:customerservice@mtibaths.com) to answer any questions pertaining to ordering or installation.



### Packages and Pricing

For more information on any of the following packages, please visit: [mtibaths.com/about-mti/therapies-for-wellness/](http://mtibaths.com/about-mti/therapies-for-wellness/)

Hydrotherapy Packages	Package Contents	Part #	MSRP
 Soaker	Soaking bath - no jets	S65-DI	\$1,970
		S65-UM	
 Air Massage	20 air jets, heated air blower, pre-leveled foam base (increases overall height 2-3")	AST65-DI	\$4,785
		AST65-UM	
 Air Massage Elite	30 air jets, heated air blower, Chromatherapy LED lighting, Spa Mode, pre-leveled foam base (increases overall height 2-3")	AE65-DI	\$6,515
		AE65-UM	
 Standard Whirlpool	6 point-massage jets, 2-bhp pump	P65-DI	\$3,910
		P65-UM	
 Air Massage with Standard Whirlpool	6 point-massage jets, 2-bhp pump, 20 air jets, heated air blower, pre-leveled foam base (increases overall height 2-3")	AW65-DI	\$6,760
		AW65-UM	
 Air Massage Elite with Standard Whirlpool	6 point-massage jets, 2-bhp pump, 30 air jets, heated air blower, Chromatherapy LED lighting, Spa Mode, pre-leveled foam base (increases overall height 2-3")	AEAP65-DI	\$8,885
		AEAP65-UM	

**Lead Time** - Soakers, Stream Bath and Whirlpool Packages - 5 business days  
Air Baths and Combo Packages - 7 business days

**NOTES:** • Aromatherapy is eliminated for undermount applications  
• Air Baths, Pre-Leveled Foam Base or Frame Systems increase overall height by 2-3".

RECOMMENDED SENSORY THERAPIES

SEE NEXT PAGE FOR AN OVERVIEW OF AVAILABLE OPTIONS.



**Chromatherapy**  
Underwater lighting is provided by digitally controlled LEDs. Different colors are thought to have different therapeutic effects.

LE - \$610



**Audiotherapy**  
Stereo H<sub>2</sub>O lets you "feel" the music through the bath water. Available with Bluetooth system or transducers with leads to connect to an external system.

STEREOH202 - \$1,135  
STEREOBT - \$1,235



**Thermaltherapy**  
Radiance uses integrated radiant heat to warm the backrest for neck, shoulders and back. Inline heaters maintain bath water temperature.

RAD100 - \$1,080  
HTISOAK - \$750



**Microbubbles**  
For wellness and beauty, billions of the tiniest air bubbles saturate the water with dissolved oxygen to moisturize and soften the skin. Available for soakers and air baths.

MICRO - \$1,745



### Options and Pricing

For more information on any of the following options, please visit: [mtibaths.com/about-products/tub-options/](http://mtibaths.com/about-products/tub-options/)

<b>Premium Options</b> NOTE: part codes for all options listed in parenthesis.
<b>Microbubbles</b> - Available on Soakers and Air Baths only (MICRO) <b>\$1,745</b>
<b>Radiance</b> - integrated tub shell heating system (RAD100) <b>\$1,080</b>
<b>Chromatherapy</b> - Included in some hydrotherapy packages underwater LED lighting (LE) <b>\$610</b>
<b>Stereo H<sub>2</sub>O - Standard System</b> - includes 4 integrated audio transducers with leads to connect to an external audio source (STEREOH202) <b>\$1,135</b> <b>Bluetooth System</b> - integrated Bluetooth system allows you to directly connect to an applicable device (STEREOBT) <b>\$1,235</b>
<b>Standard Options</b>
<b>Standard Colors:</b> White (CWH), Bone (CBN), Biscuit (CBS) <b>Color Upgrade:</b> (COL2) <b>\$500</b> , please call for availability of special colors
<b>Quick Ship</b> - reduces lead time - please call for availability (QSPRI) <b>\$380</b>
<b>Textured, Slip-Resistant Bottom</b> - meets ASTM F-462-1994 (TXBTM) <b>\$75</b>
<b>Virtual Spout</b> - high-flow integrated tub filler (FPMJ) <b>\$310</b>
<b>Inline Heater</b> - included in some hydrotherapy packages For whirlpools or Stream Bath (HTI) <b>\$545</b> Uses existing pump Soaker or Air Baths (HTISOAK) <b>\$750</b> Includes a recirculating pump.
<b>Installation Aids</b>
<b>Tile Flange</b> must specify flange location(s) on order Note: Tile flange not available with Low-Profile Rim option. Factory-Installed on 3 sides - rigid ABS (TFK3) <b>\$190</b> Field Install Kit - includes rigid ABS & adhesive (TFKNI) <b>\$175</b>
<b>Pre-Leveled Foam Base</b> - for soaker or whirlpools (PLFOAM) <b>\$175</b>
<b>Pre-Leveled Frame and Foam Base (PLF)</b> <b>\$525</b>
<b>Pre-Leveled Frame and Foam Base with Skirting</b> for skirting options and pricing, see spec at: <a href="http://mtibaths.com/wp-content/uploads/2016/01/options-skirt_acrylic.pdf">mtibaths.com/wp-content/uploads/2016/01/options-skirt_acrylic.pdf</a>

<b>Accessories &amp; Hardware for All Packages</b>
<b>Drain Kits</b> - other finishes also available
<b>Toe-Tap with Round Overflow</b> - Chrome (WOTTC) <b>\$285</b> Brushed Nickel (WOTTBN) <b>\$290</b> Polished Nickel (WOTTPN) <b>\$340</b>
<b>Cable Driven</b> - Chrome (WOCD) <b>\$315</b> Brushed Nickel (WOCDBN) <b>\$385</b> Polished Nickel (WOCDPN) <b>\$515</b> Oil-Rubbed Bronze (WOCDOR) <b>\$515</b>
<b>Lift &amp; Turn</b> -Chrome (WOC) <b>\$125</b> Brushed Nickel (WOBN) <b>\$225</b>
<b>Grab Bars</b> - 9" Curved, set of 2 Acrylic - color-matched with tub standard colors only (GB) <b>\$300</b> Metal - Chrome (GBMCC), Brushed Nickel (GBMCBN) <b>\$330</b>
<b>Pillows</b> - from <b>\$125</b> see pillows spec at: <a href="http://mtibaths.com/wp-content/uploads/2016/11/options_pillows.pdf">mtibaths.com/wp-content/uploads/2016/11/options_pillows.pdf</a>
<b>Teak Tub Tray</b> - Slatted (TK-TRAY1) or Solid (TK-TRAY2) <b>\$415</b>
<b>Teak Bath Mat</b> (TK-MAT3018) <b>\$430</b> custom sizes also available
<b>Accessories &amp; Cleaning Systems for Whirlpool Packages</b>
<b>Trim Kits</b> - must be ordered at time of purchase; other finishes available Standard Whirlpool - Chrome (TRC) <b>\$235</b> ; Brushed Nickel (TRBN) <b>\$595</b> Ultra Whirlpool - Chrome (TRCU) <b>\$320</b> ; Brushed Nickel (TRBNU) <b>\$815</b>
<b>Pump Upgrade</b> - 3-bhp (PUMP3) <b>\$245</b>
<b>Additional Jet Options</b> see jet options spec at <a href="http://mtibaths.com">mtibaths.com</a>
<b>Whirlpool Cleaning Systems</b> - Fill-Flush (FFSO) <b>\$590</b> ; Simple Touch (FFE) <b>\$710</b>
<b>Ozonator</b> - bath water purification system (OZONE) <b>\$535</b>

