



Intarcia

Model # MTCS-734
18" x 18" x 8"

Installation: vessel-style, semi-recessed or undermount

Lead Time - 10 Business Days

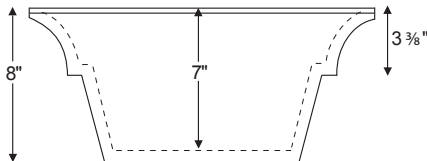
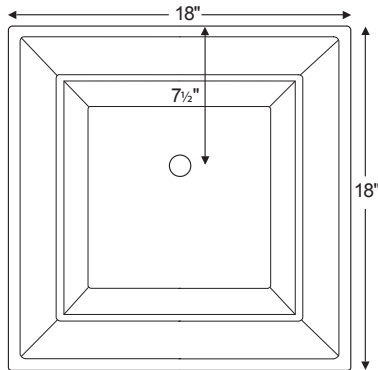

Sink Options and Pricing
NOTE: part codes for all options listed in parenthesis.
Part #: MTCS-734 - \$1,040
Standard Color - White, matte finish Biscuit Color Upgrade, matte finish - (SSBISNK) \$100
Optional Gloss Finish Upcharge - For White or Biscuit (SSGLOSSNK) \$205 Additional material colors available for projects only. Please call MTI.
Routed Channel on Sink - (RCS) \$200
Quick Ship - reduces lead time - please call for availability (QUISINKSH) \$185

Options and Accessories
NOTE: part codes for all options listed in parenthesis.
Drain Kits -
Finger Touch Drain Without Overflow Chrome (DKFGCN) \$100 Brushed Nickel (DKFGBNN) \$105
Grid Drain Without Overflow Chrome (DKGDCN) \$85 Brushed Nickel (DKGDBNN) \$100
Fixed Drain Without Overflow Chrome (DKFDC) \$185

CONSTRUCTION AND STANDARD FEATURES

- Single-bowl design; 1.5" drain opening.
- Sink has no overflow. Requires vessel-style drain kit without overflow. Check local codes.
- One-piece construction using Engineered Solid Stone (ESS) material, which is solid through and through.
- ESS is a mixture of ground natural materials and binding agents that are liquefied, poured and then hardened.
- This material is non-porous, stain-, mold- and mildew-resistant, making cleaning and maintenance easy.
- Approximately 65% of the material is organic, including minerals mined from the earth, making it "Green".
- Same material and color all the way through, with minor variations due to use of natural minerals.
- Five-Year Limited Residential Warranty.
- Shipping weight: 22 lbs.