

P.O. _____ Date: _____
 Contact name: _____
 Company / Address: _____
 Phone: _____ Fax: _____
 Email: _____

Petra Counter-Sink 10

Single Bowl - Center or Offset
 Worksheet & Order Form

MTI Order Entry Department
 Phone: 800-783-8827 Fax: 800-438-8827
 Email: orderentry@mtibaths.com

Worksheet

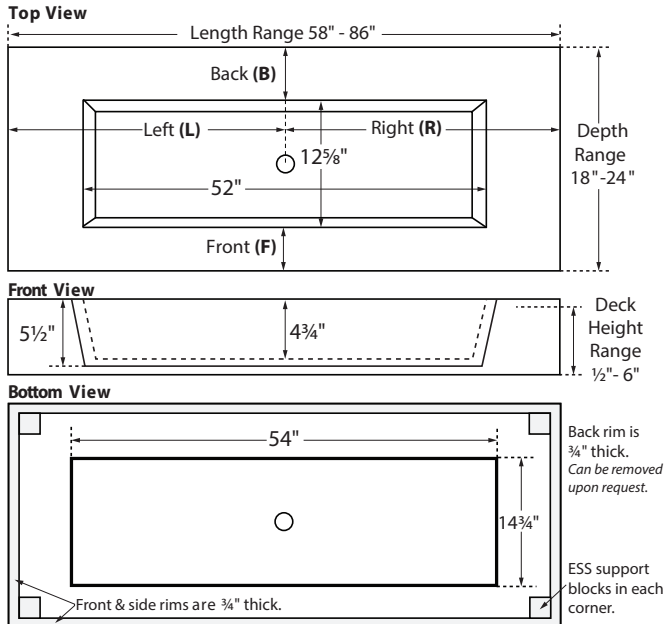

NOTE: Corner support blocks shown in above 'bottom view' are necessary only when deck height is over 1". All four sides will be finished standard, unless requested otherwise.

Important: Due to the handcrafted nature of this product, please allow for a tolerance of up to 1/4" for overall dimensions and 1/2" for bowl placement.

Countertop Measurements - including overhang*

Length _____ Depth _____ Deck Height _____

* Add a minimum overhang of 1/4" to length & depth, to ensure full coverage of any exposed side of the vanity. Additional overhang may be required depending on installation application or wall variances.

Bowl Placement Measurements

Length - Choose 'Centered' or enter a measurement from Left (L) OR Right (R).

_____ Centered on counter

_____ inches (L) from left edge of top to center of bowl.

OR

_____ inches (R) from right edge of top to center of bowl.

Depth - Enter a measurement from Back (B) OR Front (F).

_____ inches (B) from back edge of top to back edge of bowl.

OR

_____ inches (F) from front edge of top to front edge of bowl.

Installation Type - Choose one:

_____ Vanity Mount OR _____ Wall Mount

Faucet Application - Choose one:

_____ Deck Mount OR _____ Wall Mount

Order Form - See local MTI dealer for pricing.

Counter-Sink Size - Choose one of the following and enter price:				
Length	Depth	Finish	Part #	Price
> 58" up to 62"	18" up to 24"	Matte	C810-S62MT	
		Gloss	C810-S62GL	
> 62" up to 74"	18" up to 24"	Matte	C810-S74MT	
		Gloss	C810-S74GL	
> 75" up to 86"	18" up to 24"	Matte	C810-S86MT	
		Gloss	C810-S86GL	

Required Additional Information		Part #	Price
Choose one from each group and enter price:			
Colors	White	CWH	no charge
	Biscuit	CBI	no charge
Deck Height	1/2"	CDH1	no charge
	> 1/2" up to 3"	CDH2	
	> 3" up to 6"	CDH3	
Integrated Overflow	None	CION	no charge
	Front bowl installation	CIOF	
	Back bowl installation	CIOB	
Faucet Holes <small>(drilled 1-3/8" in diameter.)</small>	None	CFHN	no charge
	Up to 3	CFH	

Faucet Hole drilling instructions:

Counter-Sink Options		Part #	Price
Backsplash 4" (H) x 5/8" thick	Length 58" up to 86"	CBLG	
Sidesplash 4" (H) x 5/8" thick	Left	CSL	
	Right	CSR	
Edge Treatments	Please specify: Cove (1), Roundover (2), or Roman Ogee (3)	CET_	
Carrier Arms for wall-mounting	Two	CCA2	
	Three	CCA3	
Teak Sink Tray - for toiletries & accessories		CTKST	
Drain Kit - enter specific part # and price from dealer price sheet			

IMPORTANT CONSTRUCTION AND OPTIONS INFORMATION:

- Carefully review inside vanity specifications to ensure that there is proper clearance to accommodate the bowl, drain and optional integrated overflow, if applicable.
- Please take into consideration the thickness of material under the countertop when positioning sink bowl, using a deck-mounted faucet or adding an integrated overflow. See "bottom view" drawing above.
- Outside of overflow housing protrudes approx. 1/2" from the bowl and may impact bowl placement.
- Please submit a copy of vanity specifications with order to ensure proper fit and finish of Counter-Sink.**
- See back of this worksheet for additional construction & options info.

Distributor Signature _____



Additional construction and options information:

Edge Treatments - routed edges provide tasteful detail to further integrate with other design elements in the room.

If gloss finish is selected, it will only apply to the sink bowl, top, and vertical surface of the Counter-Sink.

The detail area will remain in a matte finish as denoted by the () in the diagrams below.*

A 1" minimum counter thickness is required for edge treatments.

Cove Edge
part# CET1

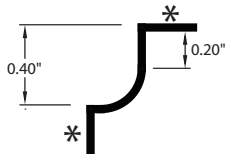
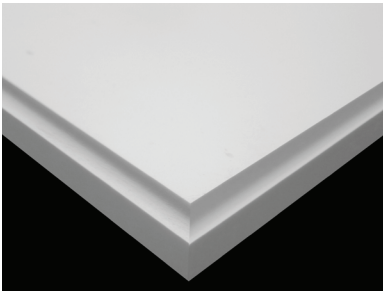

Roundover Edge
part# CET2

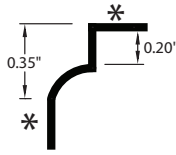
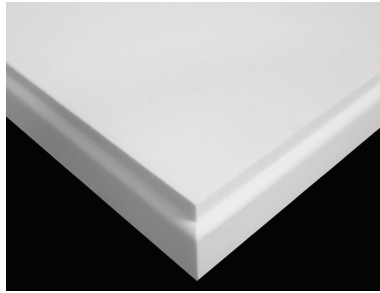

Roman Ogee Edge
part# CET3

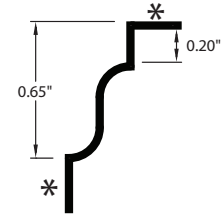
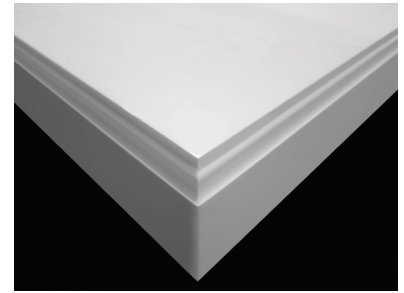

Integrated overflow can be installed on either the inside front or back wall of sink. *Note: Outside of overflow housing protrudes approx. 1/2" from the bowl and may impact bowl placement.*



Backsplash / Sidesplash - measures 4" (H) and 5/8" thick. Field-installed on finished surface of countertop. *Consider bowl placement and/or faucets when ordering.*



Overhang is material that extends over the front and/or sides of vanity.

Add a minimum overhang of 1/4" to length & depth, to ensure full coverage of any exposed side of the vanity. Additional overhang may be required depending on installation application or wall variances.



Teak Sink Tray is an ideal Counter-Sink accessory, hand crafted to fit rectangular bowls. Both stylish and practical, the MTI teak sink tray can be used as a resting place for grooming articles and toiletries. Flat slatted teak design lets water and soap run through, so there is no residue build-up.

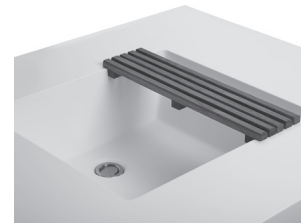

Carrier Arms are offered for wall-mount installation applications. Counter-Sink can be secured to each carrier arm using 3M construction adhesive (not supplied) for most installation applications. Check local codes.

NOTE: carrier arms must be specified on order to ensure proper fit. MTI recommends two carrier arms for most single bowl applications, although three might be necessary for Counter-Sinks 60" and up with an offset bowl.

