

Worksheet and order form must be filled out by an authorized MTI dealer.

Alissa Vanity Sink Worksheet - Double Bowl

Send this completed worksheet,
along with order form and purchase order to:

MTI Order Entry Department
Phone: 800-783-8827 Fax: 800-438-8827
Email: orderentry@mtibaths.com

Please fill in the information below:

P.O. _____ Date: _____

Contact name: _____

Company / Address: _____

Phone: _____ Fax: _____

Email: _____

Worksheet Instructions:

- Vanity Sink is available in 5 standard lengths ranging between 48" and 72". Enter exact size below. Custom lengths are not available.
- Overall height (34") and depth (22") are fixed and not customizable.
- Select whether faucet will be deck-mounted or wall-mounted.
- Enter specific bowl placement measurements for length and depth OR choose MTI's 'standard' recommended bowl placement. See next page to view 'standard' bowl placement drawings for each of the vanity lengths offered.
- Send this worksheet, along with order form and purchase order to the MTI order entry department.

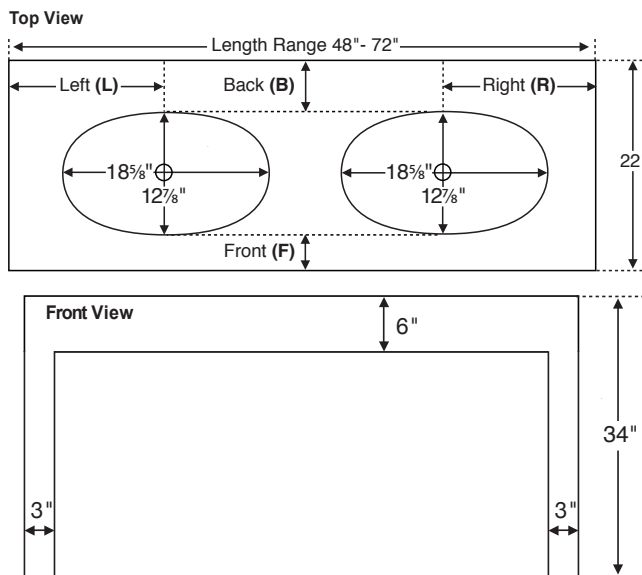

Note: Due to the handcrafted nature of this product, please allow for a tolerance of up to 1/4" for overall dimensions and 1/2" for bowl placement.

Vanity Length *Enter a size listed below:*

_____ Choose from 48", 54", 60", 66" or 72".

Faucet Application *Choose one of the following:*

_____ Deck-Mount **OR** _____ Wall-Mount

Bowl Placement Measurements

Length - Choose 'Standard' **OR** enter measurements for Left (L) **AND** Right (R).

_____ Standard bowl placement. See drawings on next page.

OR

_____ inches (L) from left edge of vanity to center of bowl.

AND

_____ inches (R) from right edge of vanity to center of bowl.

Depth - Choose 'Standard' or enter a measurement from Back (B) **OR** Front (F).

Standard bowl placement for deck-mount faucets.

_____ See drawings on next page.

OR

_____ inches (B) from back edge of top to back edge of bowl.

OR

_____ inches (F) from front edge of top to front edge of bowl.

Distributor Signature _____

Model # MTCS-V841

Effective 052016

©2016 by MTI Baths, Inc. Modification Rights Reserved.



Alissa Vanity Sink

Recommended bowl placement for sizes 48" - 72" (L)

Drawings shown below are intended to simplify the ordering process. Using the worksheet on the previous page, choose a desired Vanity Sink length, then select 'Standard Bowl Placement' for length and/or depth. Enter specific measurements for custom bowl placement.

Note: drawings below are not to scale.

48"

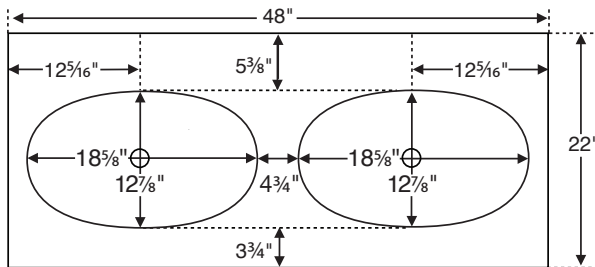

54"

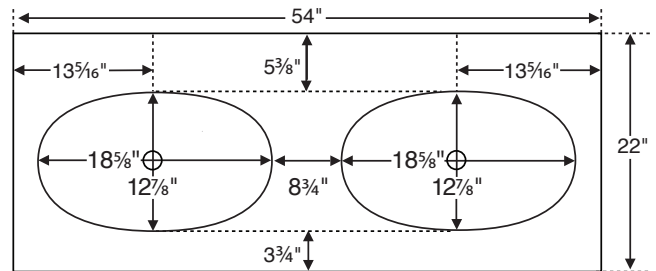

60"

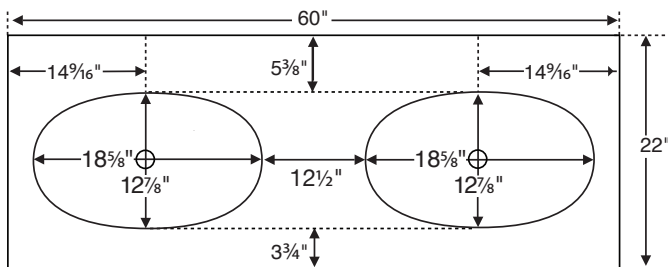

66"

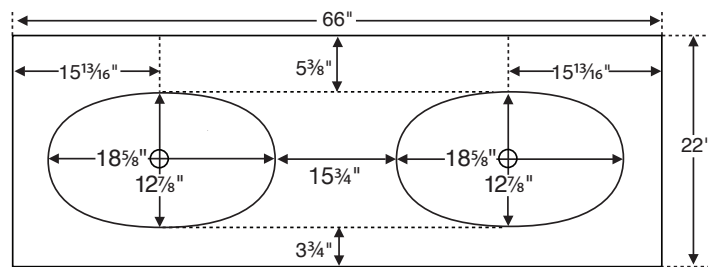

72"

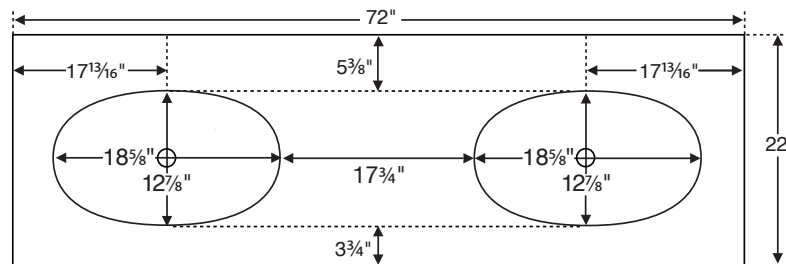

Worksheet and order form must be filled out by an authorized MTI dealer.

Vanity Sink Order Form

Double Bowl - Available in up to 5 standard lengths, depending on bowl selected, with fixed depth and height. Custom bowl placement is required for all models. Worksheet for bowl placement is available at mtibaths.com.

Vanity Size - Choose one of the following and enter price:

Length	Finish	Part #	Price
48"	Matte	CV-D48MT	
	Gloss	CV-D48GL	
54"	Matte	CV-D54MT	
	Gloss	CV-D54GL	
60"	Matte	CV-D60MT	
	Gloss	CV-D60GL	
66"	Matte	CV-D66MT	
	Gloss	CV-D66GL	
72"	Matte	CV-D72MT	
	Gloss	CV-D72GL	

Double Bowl Models - Choose one of the following and enter price:

Bowl name	Bowl size (rounded)	Fits vanity (size range)	Part #	Price
Petra 1	16" x 14"	48" to 72"	C801D	no charge
Petra 2	15" x 10"	48" to 72"	C802D	no charge
Petra 3	18" x 12"	48" to 72"	C803D	no charge
Petra 4	20" x 13"	54" to 72"	C804D	
Petra 9	13" x 8"	48" to 72"	C809D	no charge
Wymara 1	18" x 14"	48" to 72"	C821D	
Alissa	19" x 13"	48" to 72"	C841D	no charge
Halo 1	14" round	48" to 72"	C861D	no charge

Required Information

Choose one from each group and enter price:

		Part #	Price
Vanity Sink Style	Parsons	CPVS	no charge
	Waterfall	CWVS	
Colors	White	CWH	no charge
	Biscuit	CBI	no charge
Integrated Overflow	None	CION	no charge
	Rear bowl	CIOB	
Faucet Holes	None	CFHN	no charge
	Up to 6	CFH	

Options and Accessories

		Part #	Price
Backsplash 4" (H) x 5/8" thick	48" length	CBSM	
	54" to 74" length	CBLG	
Sidesplash 4" (H) x 5/8" thick	Left	CSL	
	Right	CSR	
Floating Shelf See next page for overall dimensions of each size and a listing of compatible Vanity Sink sizes.	Small - matte	CFSSMT	
	Small - gloss	CFSSGL	
	Medium - matte	CFSMMT	
	Medium - gloss	CFSMGL	
	Large - matte	CFSLMT	
	Large - gloss	CFSLGL	
	X-Large - matte	CFSXLMT	
X-Large - gloss	CFSXLGL		
Teak Sink Tray		CTKST	

Available vanity styles - choose from one of the following: See "Required Information" to the left and make a selection.

Parsons - featuring four legs with vanity open on all sides.



Waterfall - finished appearance on left & right side of vanity.



Additional construction and options information:

Integrated overflow can be installed on the inside back wall of sink.

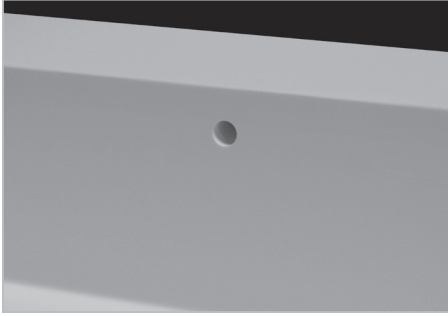

Faucet Holes - up to 6 drilled.
Standard hole size is 1-3/8" in diameter.
Must provide specific drilling instructions on order form.

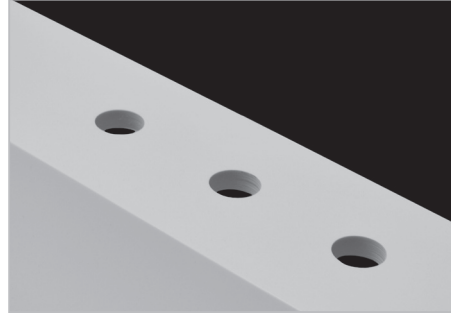

Backsplash / Sidesplash measures 4" (H) and 5/8" thick.
Field-installed on finished surface of vanity.

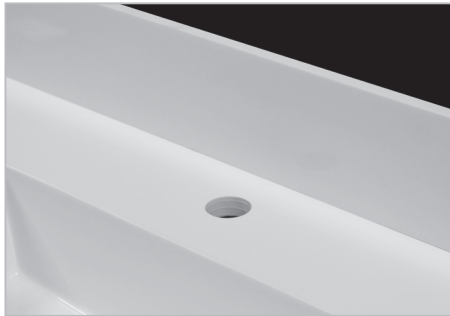

Shown above with optional backsplash.



Shown above without a backsplash.

Floating Shelf is available in four lengths: 24" (small), 30" (medium), 42" (large) and 48" (extra large). Each size measures 17" deep x 3" high and is open on the bottom side to accommodate mounting hardware (included). Wall-mounted floating shelf is designed to mount below the Vanity Sink. Shelf provides storage for towels, toiletries and a variety of bathroom accessories. *See ordering information below.*

Ordering Information:

- 24" shelf fits beneath Vanity Sink 36" and up.
- 30" shelf fits beneath Vanity Sink 42" and up.
- 42" shelf fits beneath Vanity Sink 54" and up.
- 48" shelf fits beneath Vanity Sink 60" and up.