

## DESIGNER COLLECTION SHOWER BASES TEAK ACCESSORIES

### Premium Teak Shower Seat

#### CONSTRUCTION AND STANDARD FEATURES

- Smooth, durable teak combines beauty with practicality.
- Constructed of the finest grade of Genuine Teak\*  
(see note at bottom of page).
- Flat slatted teak lets water and soap run through, so there is no slippery residue.
- Teak has the natural ability to ward off fungi, mold and mildew.
- Teak slats are 1" wide x 2" thick.
- 11-gauge tubular stainless steel frame (wall flanges 10-gauge).
- Seat is automatically held in position by a positive stop friction spring guide bracket.
- Unsurpassed quality and workmanship.
- Handcrafted and milled in the USA.
- Maximum weight limit: 500 lbs.
- Mounting hardware is NOT included with shower seat.  
See important installation information below.

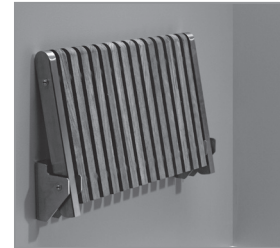
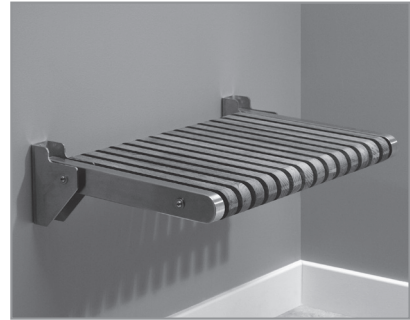

#### Premium Teak Shower Seat - Size: 24" x 16"

Natural Stainless - Part # TK-SSEAT2416BNS \$2,185

High-Polished Stainless - Part # TK-SSEAT2416BHP \$2,525

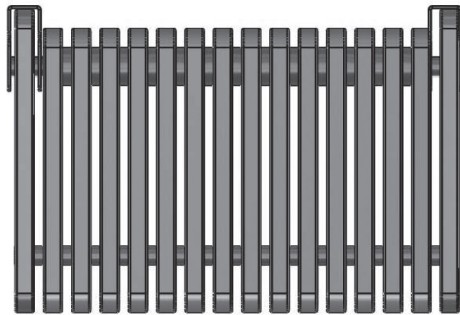

Top View

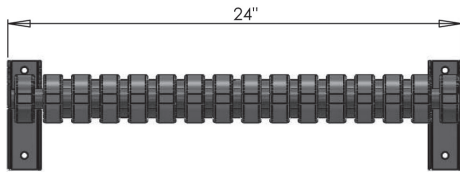

Front View

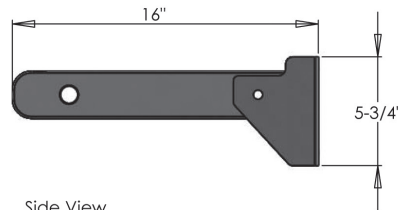
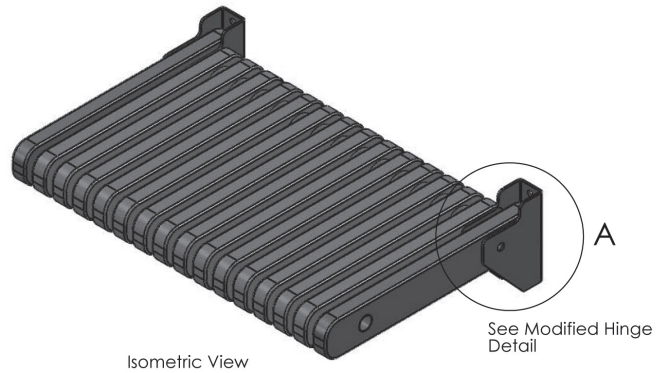

Side View

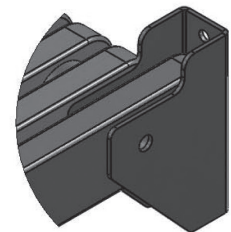

DETAIL A  
SCALE 2 : 5

**IMPORTANT INSTALLATION INFORMATION:** All shower seats **must** be installed using suitable fasteners and sufficient in-wall backing materials.

#### \*Environmentally Responsible

MTI uses only 100% U.S.-certified legal, reclaimed, sustainable teak. A replacement tree is planted 20 years before a tree is harvested. The teak used in MTI products is the finest in the world and is imported from reputable suppliers bordering Burma (Myanmar), not from Burma. MTI suppliers observe all international laws regarding labor and conservation. All of the Genuine Teak used by MTI is harvested from reclaimed forests and is absolutely not endangering or depleting rain forests.