

DESIGNER COLLECTION SHOWER BASES TEAK ACCESSORIES

Standard Teak Shower Seat

CONSTRUCTION AND STANDARD FEATURES

- Sturdy teak seat provides comfort and convenience and can be folded up when not in use.
- Constructed of the finest grade of Genuine Teak*
(see note at bottom of page).
- Teak has the natural ability to ward off fungi, mold and mildew.
- Flat slatted teak lets water & soap run through, so there is no slippery residue.
- Slats are 1-3/8" wide x 1/2" thick and joined to the 1-1/4" - square stainless steel frame with countersunk marine-grade stainless steel screws.
- All support components are manufactured of 18-gauge stainless steel (wall flanges 10-e).
- Mounting hardware not included.
- Constant friction wall-mounted bracket guides the "U"-shaped legs freely up and down, resulting in a low-pressure constant spring action to raise and lower the seat.
- Seat is automatically held in a raised position by a positive stop friction spring guide bracket.
- Handcrafted and milled in the USA.
- Maximum weight limit: 350 lbs.



Standard Teak Shower Seat - Size: 22" x 15"

Natural Stainless - Part # TK-SSEAT2215NS **\$810**

High-Polished Stainless - Part # TK-SSEAT2215HP **\$1,035**

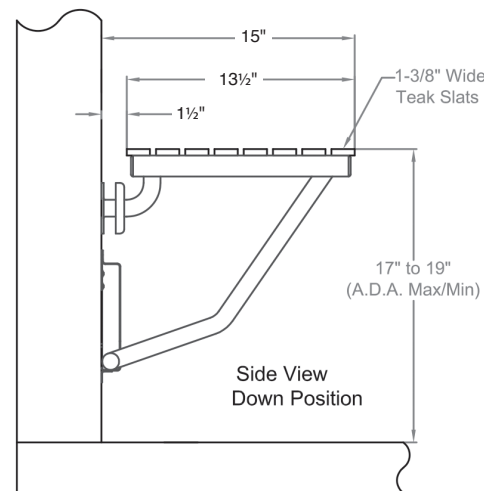
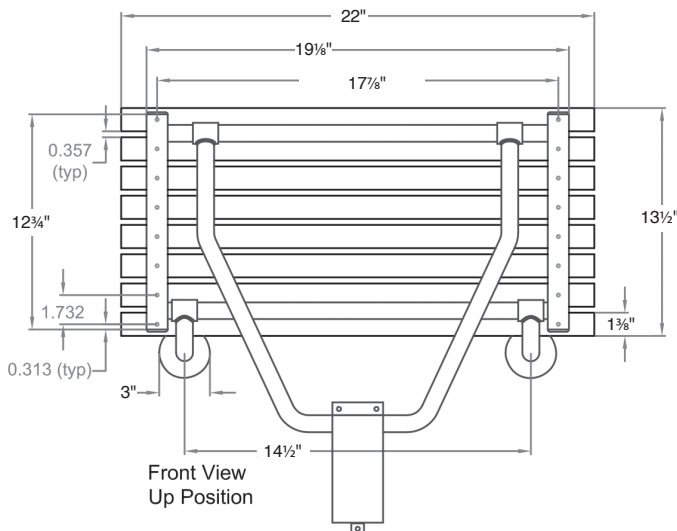

IMPORTANT INSTALLATION INFORMATION: All shower seats **must** be installed using suitable fasteners and sufficient in-wall backing materials.

*Environmentally Responsible

MTI uses only 100% U.S.-certified legal, reclaimed, sustainable teak. A replacement tree is planted 20 years before a tree is harvested. The teak used in MTI products is the finest in the world and is imported from reputable suppliers bordering Burma (Myanmar), not from Burma. MTI suppliers observe all international laws regarding labor and conservation. All of the Genuine Teak used by MTI is harvested from reclaimed forests and is absolutely not endangering or depleting rain forests.